

POWER SUPPLY 200-240 Vac 24 V 500 W

- IP65 and IP67 degree of protection
- 1000 W_{peak} 5 s
- AC 200-240 V
- Output connected to PE (PELV/ES1)
- 94.8 % full load and excellent partial load efficiencies
- Full power between -30 °C and +55 °C
- Negligibly low input inrush current surge
- High immunity to transients and power surges
- Low electromagnetic emissions
- Large output capacitors
- IO-Link interface
- 3 year warranty

PRODUCT DESCRIPTION

The **FPH500** is an industrial grade power supply for a 1-phase mains system that is incorporated into a rugged wall-mount housing with an IP65 and IP67 degree of protection.

It provides 4 stabilised outputs that are galvanically insulated from the input. The negative terminals of the outputs are permanently connected to PE within the unit.

The most outstanding features of the FPH series are compact size, wide operating temperature range, extremely low input inrush current and very high efficiencies, which are achieved through various design topologies. The large output capacitors can absorb and store regenerative energy from braking motors.

High immunity to transients and power surges as well as low electromagnetic emissions and an international approval package make the use in nearly every application possible.

SHORT-FORM DATA

Output voltage	DC 24 V	nominal
Adjustment range	24-28 V	factory setting 24.5 V
Output power	500 W	up to +55 °C ambient
	350 W	up to +70 °C ambient
BonusPower	600 W	up to +45 °C ambient
Short term (5 s)	1000 W	up to +55 °C ambient
	700 W	up to +70 °C ambient
	Derate linearly between +45 °C to +70 °C	
Number of outputs	4	
Output currents	settable per output: 4x up to 10 A	
Input voltage AC	AC 200-240 V	-15 / +10 %
Input voltage DC	DC 200-300 V ¹⁾	-15 / +20 %
Power factor	0.985	at 230 Vac
AC Inrush current	6 A _{peak}	at 230 Vac
Efficiency	94.8 %	at 230 Vac
Power Losses	27.8 W	at 230 Vac
Hold-up time	24 ms	at 230 Vac
Temperature range	-30 °C to +70 °C	
Size (wxhxd)	181x183x59 mm	without connectors
Weight	1200 g	

¹⁾ For DC supply voltages an external fuse is required.

ORDER NUMBERS

FPH500.245-047-154	Power supply	
	Input	Output
	7/8" 3pin	7/8" 4pin

Complementary units:

ZM.FPDRA-11	DIN rail mounting kit
ZM.FPMBA-11	Mounting bracket

MAIN APPROVALS

For details and a complete approval list, see chapter 19.



IEC 62368-1
IEC 61010-2-201

UL 61010

Index

1	Intended Use.....	4	17	Safety and Protection Features.....	24
2	Installation Instructions.....	4	18	Dielectric Strength.....	25
3	AC Input.....	5	19	Approved, Fulfilled or Tested Standards.....	26
4	DC Input.....	6	20	Regulatory Product Compliance.....	26
5	Input Inrush Current.....	6	21	Accessories.....	27
6	Output.....	7	21.1	DIN Rail Mounting Kit: ZM.FPDRA-11.....	27
7	Hold-up Time.....	8	21.2	Mounting Bracket: ZM.FPMBA-11.....	27
8	IO-Link Interface.....	9	22	Application Notes.....	28
9	Efficiency and Power Losses.....	14	22.1	Repetitive Pulse Loading.....	28
10	Lifetime Expectancy.....	15	22.2	External Input Protection.....	28
11	MTBF.....	15	22.3	Inductive and Capacitive Loads.....	28
12	Functional Diagram.....	16	22.4	Back-Feeding Loads.....	28
13	Dimensions and Connectors.....	17	22.5	Parallel Use to Increase Output Power.....	28
14	User Interface.....	18	22.6	Series Operation.....	28
15	EMC.....	21	22.7	Mounting Orientations.....	29
16	Environment.....	23			

The information given in this document is correct to the best of our knowledge and experience at the time of publication. If not expressly agreed otherwise, this information does not represent a warranty in the legal sense of the word. As the state of our knowledge and experience is constantly changing, the information in this data sheet is subject to revision. We therefore kindly ask you to always use the latest issue of this document (available under www.pulspower.com).

No part of this document may be reproduced or utilised in any form without our prior permission in writing.

Packaging and packaging aids can and should always be recycled. The product itself may not be disposed of as domestic refuse.

Terminology and Abbreviation

PE and \oplus Symbol	PE is the abbreviation for Protective Earth and has the same meaning as the symbol \oplus .
FE, Earth, Ground (GND)	This document uses the term "earth" which is the same as the U.S. term "ground".
t.b.d.	To be defined, value or description will follow later.
230 V	A figure displayed with the AC or DC before the value represents a nominal voltage with standard tolerances (usually $\pm 15\%$) included. E.g.: DC 12 V describes a 12 V battery disregarding whether it is full (13.7 V) or flat (10 V)
230 Vac	A figure with the unit (Vac) at the end is a momentary figure without any additional tolerances included.
50 Hz vs. 60 Hz	As long as not otherwise stated, AC 230 V parameters are valid at 50 Hz mains frequency.
may	A key word indicating flexibility of choice with no implied preference.
shall	A key word indicating a mandatory requirement.
should	A key word indicating flexibility of choice with a strongly preferred implementation.

Nomenclature

Detail	Description
FPT	380-480 V 3-phase power supply
FPS	100-240 V 1-phase power supply
FPH	200-240 V 1-phase power supply
300	300 W power class
500	500 W power class
241 / 481	Standard power supply with output voltage 24 - 28 V / 48 - 52 V setting and LED bar
242 / 482	Basic power supply without voltage setting and LED bar. This version has status LEDs.
245 / 485	Power supply with up to 4 eFuse channels
246 / 486	Power supply with up to 4 NEC Class 2 channels
247 / 487	Power supply with NEC Class 2 and eFuse channel
0xx	Terminal configuration e.g. .002. Input: Han Q 4/2 Com: M12-A Output: Han Q 4/0
1xx	Consecutively numbered

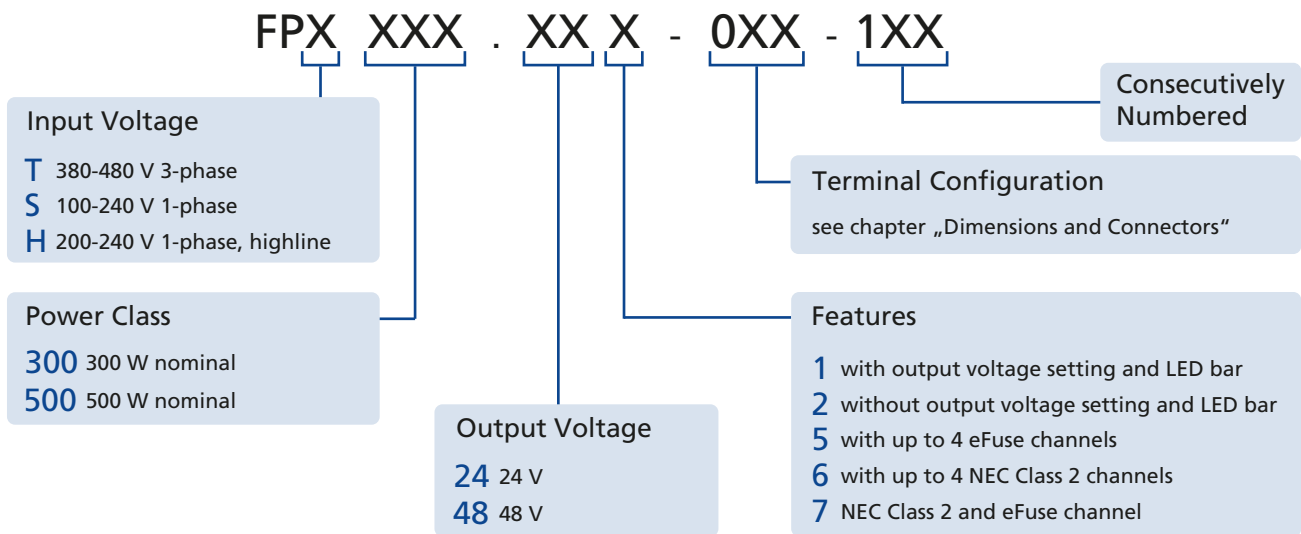

1. Intended Use

This device is designed for indoor use and is intended for commercial use, such as in industrial control, process control, monitoring and measurement equipment.

Do not use this device in equipment where malfunction may cause severe personal injury or threaten human life. If this device is used in a manner outside of its specification, the protection provided by the device may be impaired.

2. Installation Instructions

⚠ DANGER Risk of electrical shock, fire, personal injury or death

- Turn power off before working on the device. Protect against inadvertent re-powering.
- Do not open, modify or repair the device.
- Do not open the unit as high voltages are present inside.
- Do not touch during power-on and immediately after power-off. Hot surfaces may cause burns.
- Install the device on a large enough flat surface. Sharp edges on the back may cause injury.
- If damage or malfunction occur during installation or operation, immediately turn power off and send unit to the factory for inspection.
- The device is designed as “Class of Protection I” equipment according to IEC 61140. Do not use without a proper PE (Protective Earth) connection.

⚠ WARNING Risk of damages to the device

- Keep the following minimum installation clearances: 50 mm on top and 10 mm on the left and right side.
- The maximum surrounding air temperature is +70 °C. The operational temperature is the same as the ambient or surrounding air temperature and is defined 3 cm below the device.
- The device is designed to operate in areas between 5 % and 95 % relative humidity.
- Clean only with a damp cloth.

Obey the following installation instructions:

This device may only be installed and put into operation by qualified personnel. This device does not contain serviceable parts. The tripping of an internal input fuse is caused by an internal defect. Install the device onto a flat surface with the terminals on the bottom of the device. Other mounting orientations require a reduction in output power, see chapter 22.7.

For wall mounting use 4 screws. Two on top and 2 on bottom mounting holes. Recommended screw size is M4 (UNC 8-32). The enclosure of the device provides a degree of protection of IP65 and IP67 when installed with all mating connectors firmly connected. The device is designed for pollution degree 3 areas in controlled environments.

Assure that during installation no moisture or dirt gets into the connections. Operation in areas where moisture or condensation can be expected is possible.

The negative potential of the outputs is permanently connected to PE within the unit. Do not connect the negative potential of any output to PE outside the unit.

For TN-, TT-mains systems with earthed neutral and IT star mains systems with insulation monitoring the device is designed for overvoltage category III zones up to 2000 m and for overvoltage category II zones up to 5000 m.

For TN-, TT-, IT-delta mains systems or IT star mains systems without insulation monitoring the device is intended for overvoltage category II zones up to 2000 m.

The device is designed for altitudes up to 5000 m. Above 2000 m a reduction in output current is required and the operation is limited according mains systems described above. The device is designed, tested and approved for branch circuits up to 20 A (UL) and 32 A (IEC) without additional protection device. If an external fuse is utilized, do not use circuit breakers smaller than 6 A B- or C-characteristic to avoid an unintentional tripping. A disconnecting means shall be provided for the input of the device. This must be suitably located and easily accessible. The disconnecting means must be marked as such for the device.

3. AC Input

The device is suitable to be supplied from TN-, TT- or IT-mains networks. For more details, see chapter 2.

AC input voltage rated range nom.	AC 200-240 V	-15 / +10 %
AC input operating range	170-264 Vac	
	264-300 Vac	for max. 500 ms
Input frequency	nom. 50-60 Hz	±6 %
Turn-on voltage	typ. 168 Vac	steady-state value, see Fig. 3-1
Shut-down voltage	typ. 158 Vac	steady-state value, see Fig. 3-1
External input protection	see recommendations in chapter 2	

AC 230 V

Input current	typ. 2.81 A	at 500 W, see Fig. 3-3
Power factor ¹⁾	typ. 0.985	at 500 W, see Fig. 3-4
Start-up delay	typ. 2000 ms	at 500 W, see Fig. 3-2
Rise time	typ. 32 ms	at 500 W, const. current load, 0 mF, see Fig. 3-2
	typ. 68 ms	at 500 W, const. current load, 12.5 mF, see Fig. 3-2
Turn-on overshoot	max. 200 mV	see Fig. 3-2

1) The power factor is the ratio of the true (or real) power to the apparent power in an AC circuit.

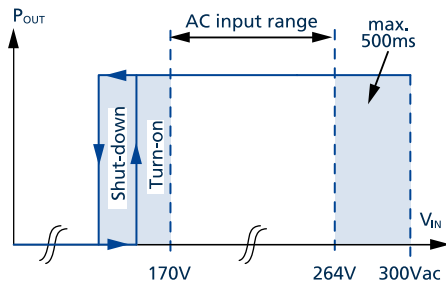

Fig. 3-1: Input voltage range

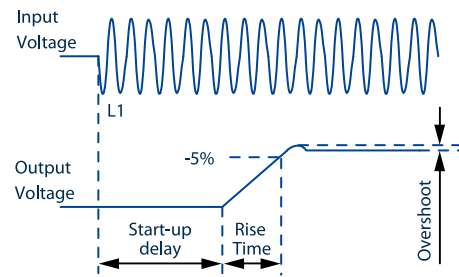

Fig. 3-2: Turn-on behaviour, definitions

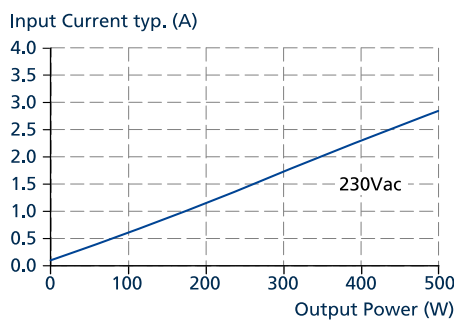

Fig. 3-3: Input current vs. output power at 24 V output voltage

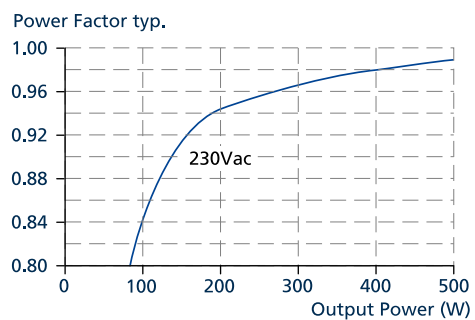

Fig. 3-4: Power factor vs. output power at 24 V output voltage

4. DC Input

DC input	nom.	DC 200-300 V ¹⁾	-15 / +20 %
DC input range		170-360 Vdc	
DC input current	typ.	3.4 A	at 200 Vdc, 24 V, 500 W
	typ.	2.2 A	at 300 Vdc, 24 V, 500 W
Turn-on voltage	typ.	168 Vdc	steady-state value
Shut-down voltage	typ.	158 Vdc	steady-state value

¹⁾ For DC supply voltage an external fuse with an appropriate rating is required.

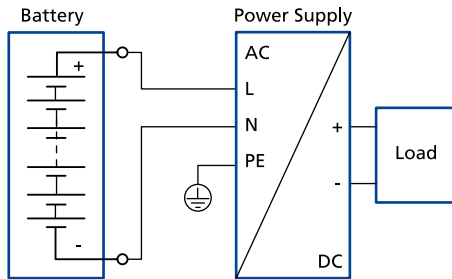

Fig. 4-1: Wiring for DC Input

Instructions for DC use:

- Use a battery or a similar DC source. A supply from the intermediate DC-bus of a frequency converter is not recommended and can cause a malfunction or damage the unit.
- Connect (+) pole to L and (-) pole to N.
- Connect the PE terminal to an earth wire or to the machine ground.

5. Input Inrush Current

An active inrush limitation circuit (NTCs, which are bypassed by a relay contact) limits the input inrush current after turn-on of the input voltage. The charging current into EMI suppression capacitors is disregarded in the first microseconds after switch-on.

AC 230 V

Inrush current	max.	6 A _{peak}
----------------	------	---------------------

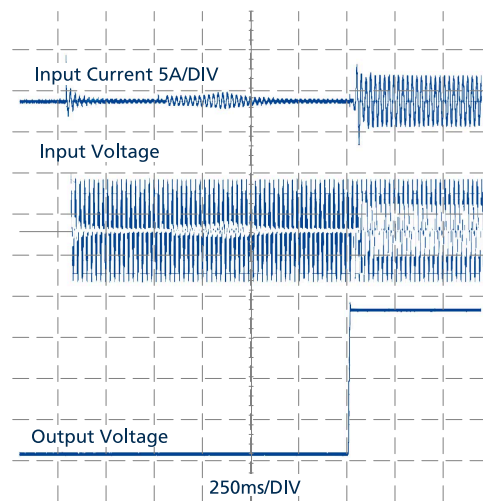

Fig. 5-1: Typical turn-on behavior at nominal load and +25 °C ambient temperature

6. Output

The outputs provide a (PELV/ES1) rated voltage, which is galvanically isolated from the input voltage. The negative potential of the outputs is permanently connected to PE within the unit. Do not connect any output to PE (Ground).

A capacity > 20 mF on one of the outputs might trip the output, due to overcurrent.

All outputs are individually current limited. In case of an overload, the individual output switches off and needs to be reset manually with the reset button on the front of the device or via IO-Link. A cycling of the input power does not reset the output. The failure signals are stored until a reset is intentionally initiated.

If an output is turned off, it can't be reset for 5 seconds, due to protection reasons. The unit is shipped with all outputs turned on.

The sum of the configured output power of all outputs may exceed the total output power of available power budget, see Fig. 6-2. If this is the case, the output with the highest number will be tripped first followed by the next output to ensure that the lower channel number will supply continuous power and see no voltage dips.

Outputs start sequentially from 1 to 4 with an interval of 150 ms, see Fig. 6-1.

Number of outputs		4	
Output voltage	nom.	24 V	
Adjustment range		24-28 V	adjustable in steps: 24 V, 24.5 V, 25 V, 25.5 V, 26 V, 26.5 V, 27 V and 28 V
Factory settings	typ.	24.5 V	±0.2 %, at nominal load
Line regulation	max.	25 mV	between 170 and 300 Vac input voltage change
Load regulation	max.	250 mV	between 0 and 600 W output load, static value
Ripple and noise voltage	max.	50 mVpp	bandwidth 20 Hz to 20 MHz, 50 Ohm
Output current	Out 1 2 Out 3 4	4x up to 10 A	
Total output power	nom.	500 W	up to +55 °C ambient temperature, for all outputs in total
	nom.	350 W	up to +70 °C ambient temperature, for all outputs in total
BonusPower	nom.	600 W	up to +45 °C ambient temperature, for all outputs in total
Short term up to 5 s	nom.	1000 W	up to +55 °C ambient temperature, for all outputs in total
	nom.	700 W	up to +70 °C ambient temperature, for all outputs in total
			Derate linearly between +45 °C and +70 °C, see Fig. 16-1.
Overload behaviour		trip curve	see Fig. 6-3
Output capacitance	typ.	12 500 µF	included inside the power supply, for all outputs in total
Back-feeding loads	max.	35 V / 4 J	

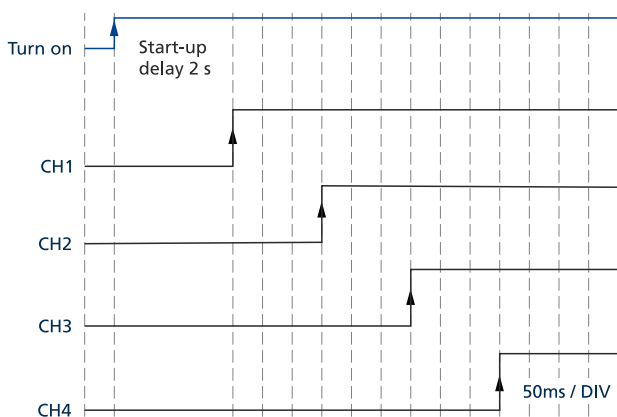

Fig. 6-1: Sequential start of the outputs

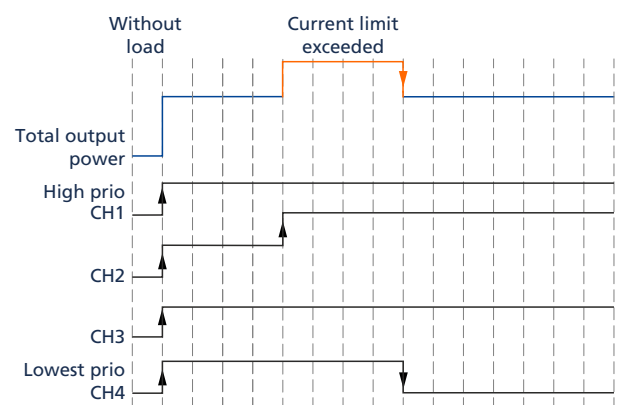

Fig. 6-2: Tripping of the channel with the lowest priority when the power budget is exceeded

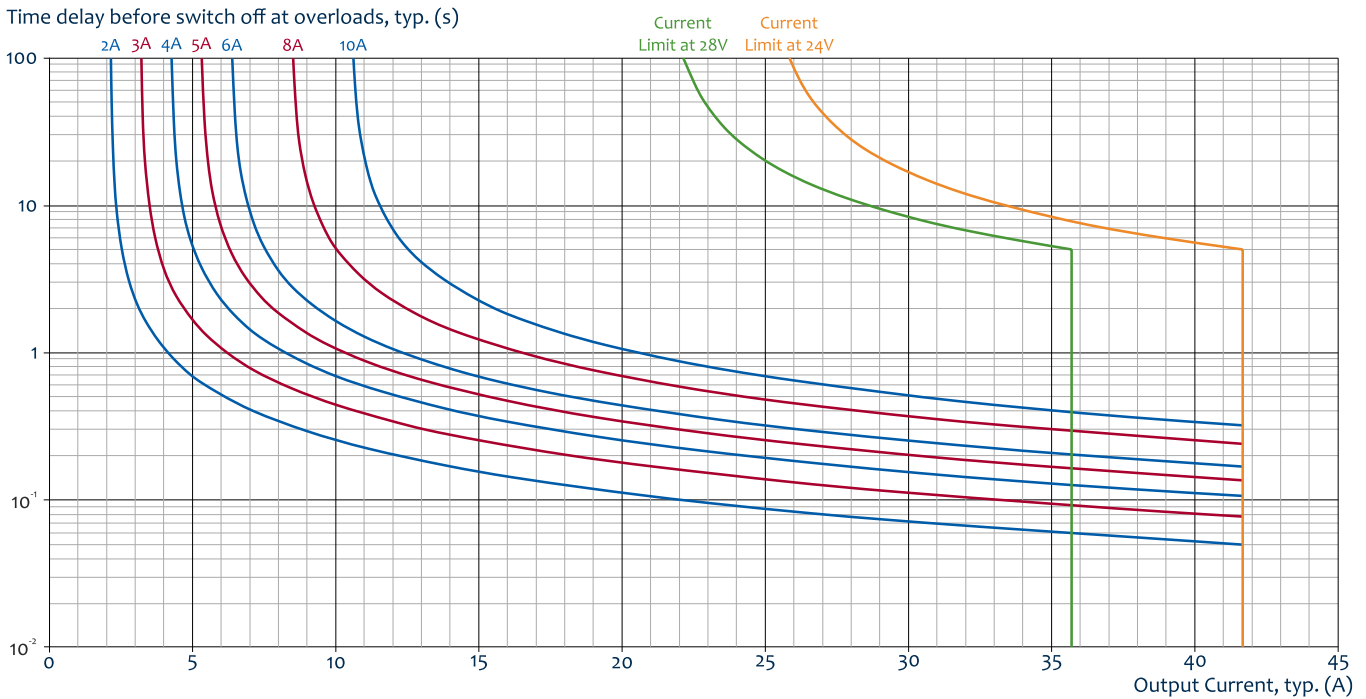

Fig. 6-3: Tripping curve diagram

7. Hold-up Time

The hold-up time is the time during which a power supply's output voltage remains within specification following the loss of input power. The hold-up time is output load dependent. At no load, the hold-up time can be up to several seconds. The status LED is also on during this time.

AC 230 V

Hold-up time	typ.	47 ms	at 250 W output load, see Fig. 7-1
	min.	40 ms	at 250 W output load, see Fig. 7-1
	typ.	24 ms	at 500 W output load, see Fig. 7-1
	min.	20 ms	at 500 W output load, see Fig. 7-1

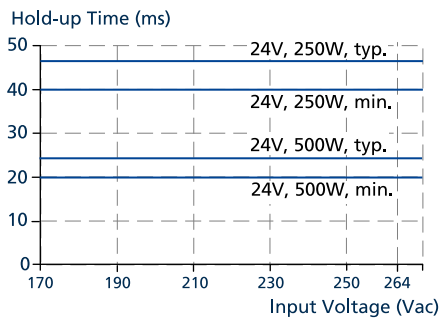

Fig. 7-1: Hold-up time vs. input voltage

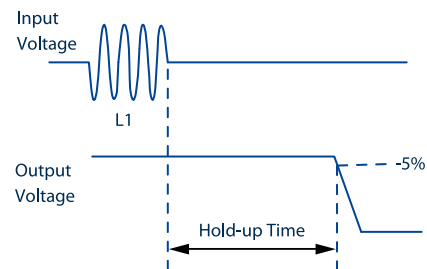

Fig. 7-2: Shut-down behavior, definitions

8. IO-Link Interface

The IO-Link interface used in this power supply is compliant to IO-Link protocol V1.1 and can be connected to any IO-Link masters compliant to V1.1 of the IO-Link protocol. This allows a transparent data flow to the sensors and actuators and therefore more transparent and easier way to monitor the current status of the power supply.

If no IO-Link connectivity is available, the power supply continues to operate without interruption. Due to a built-in EEPROM, previously stored data is retrieved from its memory.

To operate the IO-Link interface it is required to install/upload the IODD-File (IO-Link Device Description) into the connected IO-Link master. The most recent IODD file can be found on the PULS website (www.pulspower.com) in the download section of the individual product page and in the IODD Finder (<https://ioddfinder.io-link.com>). The device can also be accessed via IO-Link, if the power supply is not connected to AC-mains and in a switched off mode.

IO-Link version	V1.1	
IO-Link master version	V1.1	
Baud-Rate	COM3 (230.4 kBaud)	
Conforms to	IO-Link Interface and System Specification, V1.1.2, July 2013	
Device ID	0x000019	
Vendor ID	1093	Hex: 04 45
Supported profiles	identification and diagnosis	
Cycle Time	2 ms	cycle time refers to the reloading speed of certain process data
SIO-Mode	yes	Class B
Process data length	15 bytes	
Block parameterisation	yes	
Data storage	yes	

The power supply provides three categories of data via IO-Link. They are divided between read only or read- and customisable data.

Control settings

This set of data is customisable. The data in control settings can be adjusted to the user's preference to ensure an even better operation of the power supply. Typical control settings are e.g. setting tripping points, setting pre-alarm levels, etc.

Parameter write	Value range	Description
Output voltage setpoint	24.0-28.0 V	output voltage setpoint pre-setting: 24.5 V
Standby	0 - unit is operating 1 - unit in standby	Power supply can be switched into standby, where all outputs turn off. pre-setting: 0 - unit is operating
Configuration setting	0 - HMI only 1 - IO-Link only 2 - both 3 - none (button lock)	Controls the configurability of the power supply, which can be restricted to local HMI or IO-Link only. Configuration can also be blocked completely. pre-setting: 2 - both
eFuse channel on / off	0 - OFF 1 - ON	Used to control the state of output channel switches (ON / OFF) or to reconnect a tripped channels. Bit coded parameter. pre-setting: 1 - ON for all channels
eFuse trip value channel 1 to channel 4	1-10 A or 1-12 A	Defines the output current threshold for each eFuse channel, where the electronic fuse is triggered. pre-setting: 10 A or 12 A (see chapter output)
eFuse pre-alarm level channel 1 to channel 4	10-150 %	Defines the threshold for the event "Output current pre-alarm for each channel". pre-setting: 80 %
Power supply total output current pre-alarm level	1-100 A	Defines the threshold for the event "power supply output current pre-alarm". To suppress event generation, set this value to max. (100 A). pre-setting: 20 A

All parameters are specified at 24 V, 500 W, 230 Vac, 25 °C ambient and after a 5 minutes run-in time unless otherwise noted.

Parameter

The parameter values can be accessed to read out additional data (e.g. current output voltage, temperatures etc.)

Parameter read	read out value range	Description
Output voltage setpoint	24.0-28.0 V	output voltage setpoint pre-setting: 24.5 V
Standby	0 - unit is operating 1 - unit in standby	Power supply can be switched into standby, where all outputs turn off. pre-setting: 0 - unit is operating
Configuration setting	0 - HMI only 1 - IO-Link only 2 - both 3 - none (button lock)	Controls the configurability of the power supply, which can be restricted to local HMI or IO-Link only. Configuration can also be blocked completely. pre-setting: 2 - both
eFuse channel on / off	0 - OFF 1 - ON	Used to control the state of output channel switches (ON / OFF) or to reconnect a tripped channels. bit coded parameter. pre-setting: 1 - ON for all channels
eFuse trip value channel 1 to channel 4	1-10 A or 1-12 A	Defines the output current threshold for each eFuse channel, where the electronic fuse is triggered. pre-setting: 10 A or 12 A (see chapter output)
eFuse pre-alarm level channel 1 to channel 4	10-150 %	Defines the threshold for the event "Output current pre-alarm for each channel". pre-setting: 80 %
Power supply total output current pre-alarm level	1-100 A	Defines the threshold for the event "power supply output current pre-alarm". To suppress event generation, set this value to max (100 A). pre-setting: 20 A
EEPROM Status	0 - OK 1 - recoverable error 2 - unrecoverable error	Power supply internal EEPROM status information. If unrecoverable error is detected, the power supply may operate with pre-setting values.
Power supply events	bit 0 - DC-OK bit 1 - DC-Warning bit 2 - Bonus Power bit 3 - Over temperature CAP bit 4 - Over temperature power supply bit 5 - Over load bit 6 - High voltage input bit 7 - Low voltage input bit 8 - Power supply down bit 9 - Predictive maintenance power supply bit 10 - 2 phase operation bit 12 - power supply settings changed via HMI bit 13 - power supply hardware failure	Collection of active events of the power supply. bit-coded parameter, bits 11, 14 - 15 not used
Temperature secondary inside	-40 to +150 °C	temperature at secondary DC output area inside power supply
Max. temperature secondary inside	-40 to +150 °C	maximum temperature at secondary DC output area inside power supply
Temperature primary inside	-40 to +150 °C	temperature at primary AC input area inside power supply
Max. temperature primary inside	-40 to +150 °C	maximum temperature at primary AC input area inside power supply
AC input voltage RMS		actual input voltage RMS (phase-phase)
Actual output voltage	0-49 V	actual average output voltage
Actual output current	0-50 A	actual average total output current

All parameters are specified at 24 V, 500 W, 230 Vac, 25 °C ambient and after a 5 minutes run-in time unless otherwise noted.

Parameter read	read out value range	Description
eFuse current channel 1 to channel 4	0-27.5 A	actual average eFuse output current for each eFuse channel
eFuse output status	bit 0 - CH1 bit 1 - CH2 bit 3 - CH4	actual state of eFuse output channels bit coded parameter. 0 - channel is OFF 1 - channel is ON
eFuse trip status channel 1 to channel 4	0 - no trip 1 - over-load trip 2 - short circuit trip 3 - temperature trip 4 - power budget trip 5 - installation failure trip 6 - sensor fault trip 7 - fatal fault trip	actual trip state of eFuse channel If the eFuse has tripped, this parameter gives detailed information about the reason. This information might help for failure analysis in the application.
Stress level	0 - "< 5 %" 1 - "> 5 %" 2 - "> 25 %" 3 - "> 50 %" 4 - "> 75 %"	Stress level based on output power delivery. This parameter gives an indication about the total power consumption of the application and the remaining margin.
Remaining endurance LED coded	0 - "< 10 %" 1 - "> 10 %" 2 - "> 25 %" 3 - "> 50 %" 4 - "> 75 %"	This parameter gives an estimated remaining endurance indication in percent. Overall performance of the power supply might decrease at low remaining endurance code.
Remaining endurance	10-99 %	This parameter gives an estimated remaining endurance indication in percent. Overall performance of the power supply might decrease at low remaining endurance.

Counter		
eFuse number of startups channel 1 to channel 4	0 - 150000	Counts the number of startups on each eFuse channel over the whole lifetime.
eFuse number of overcurrents channel 1 to channel 4	0 - 65535	Number of Overcurrents on each eFuse channel over the whole lifetime.
Operating time		
hours	0 - 1193046	total operating hours
minutes	0 - 59	operating minutes
Transient VDE-0160 Counter overall	0 - 150000	transient counter overall
Transient VDE-0160 Counter last 2 minutes	0 - 65535	transient counter last 2 minutes
Turn-on Counter	0 - 150000	turn-on counter of the power supply
Uptime since last turn-on		
hours	0 - 1193046	uptime since last turn-on - hours
minutes	0 - 59	uptime since last turn-on - minutes
Device Status		
Device status	0 - device is operating properly 1 - maintenance-required 2 - out-of-specification 3 - functional-check 4 - failure	overall power supply device state
Detailed Device Status	Octet	shows up to 5 pending events
Item [1]	Strings	3 octets per subindex-
Item [2]		Octet 1 - EventQualifier
Item [3]		Octet 2, 3 - EventCode
Item [4]		
Item [5]		

Event Data

This set of data is on read only. Event data reports on parameter errors and warns of device failures of the power supply to the IO-Link master. It is triggered when certain critical conditions or control settings are exceeded.

Events	Event-type	Description
Parameter error – check data sheet and values	Error	
Device temperature over-run – clear source of heat	Warning	
Events DC-Warning	Warning	output voltage dips more than 10 % below adjusted output voltage
Events Bonus Power	Notification	output current is 5 % more than maximum for more than 1 s
Events overload	Warning	load higher than allowed
Events high voltage input	Warning	input to high
Events low voltage input	Warning	input to low
Events power supply down	Warning	no link from IO-Link transceiver to power supply
Events predictive maintenance power supply	Warning	The estimated remaining lifetime has reached 10 %. Performance of power supply might be limited due to aging effects of components.
Events power supply setting changed via HMI	Warning	A power supply setting was changed via human-machine interface.
Events power supply hardware failure	Warning	Critical power supply hardware failure detected.
Events power supply output current pre-alarm	Warning	total power supply output current exceeds pre-alarm limit for more than 2 s

All parameters are specified at 24 V, 500 W, 230 Vac, 25 °C ambient and after a 5 minutes run-in time unless otherwise noted.

Events	Event-type	Description
Events eFuse channel 1 to channel 4	Warning	for each eFuse channel when is tripped due to overcurrent
Events output current pre-alarm channel 1 to channel 4	Notification	for each eFuse channel when output current exceeds pre-alarm limit for more than 2 s

Process Data

This set of data is on read only. Process data reports on the current state and conditions of the power supply to the IO-Link master.

Process	Value range	Description
Actual output total current	A	
Actual output voltage	V	actual output voltage
eFuse currents channel 1 to channel 4	A	actual output current from each eFuse channel
eFuse channel states		actual state of eFuse outputs (ON / OFF)
eFuse overload trip states		overload trip state of eFuse outputs (ok / tripped)
eFuse short circuit states		short circuit trip state of eFuse outputs (ok / tripped)

9. Efficiency and Power Losses

AC 230 V			
Efficiency	typ.	94.8 %	at 24 V, 500 W
Average efficiency ¹⁾	typ.	94.5 %	25 % at 120 W, 25 % at 250 W, 25 % at 370 W, 25 % at 500 W
Power losses	typ.	2.6 W	at 24 V, 0 W
	typ.	13.1 W	at 24 V, 250 W
	typ.	27.8 W	at 24 V, 500 W
	typ.	31.5 W	at 24 V, 600 W

1) The average efficiency is an assumption for a typical application where the power supply is loaded with 25 % of the nominal load for 25 % of the time, 50 % of the nominal load for another 25 % of the time, 75 % of the nominal load for another 25 % of the time and with 100 % of the nominal load for the rest of the time.

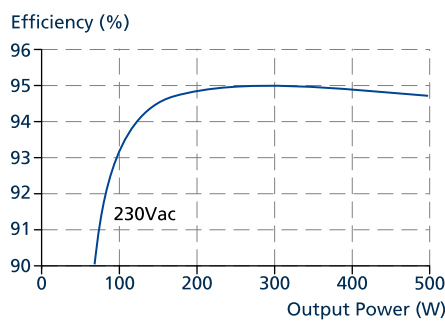

Fig. 9-1: Efficiency vs. output power at 24 V, typ.

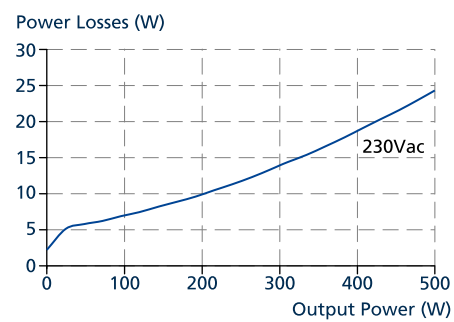

Fig. 9-2: Losses vs. output power at 24 V, typ.

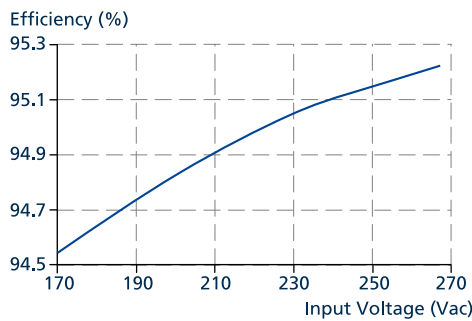

Fig. 9-3: Efficiency vs. input voltage at 24 V, 500 W, typ.

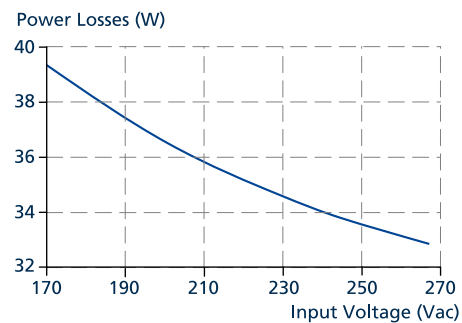

Fig. 9-4: Losses vs. input voltage at 24 V, 500 W, typ.

10. Lifetime Expectancy

The lifetime expectancy shown in the table indicates the minimum operating hours (service lifetime) and is determined by the lifetime expectancy of the built-in electrolytic capacitors. Lifetime expectancy is specified in operational hours and is calculated according to the capacitor's manufacturer specification. The manufacturer of the electrolytic capacitors only guarantees a maximum lifetime of up to 15 years (131 400 h). Any number exceeding this value is a calculated theoretical lifetime, which can be used to compare devices.

	AC 230 V	
Calculated lifetime expectancy	65 800 h	at 24 V, 500 W and +40 °C
	187 600 h	at 24 V, 250 W and +40 °C
	149 300 h	at 24 V, 500 W and +25 °C
	550 500 h	at 24 V, 250 W and +25 °C

11. MTBF

MTBF stands for **Mean Time Between Failures**, which is calculated according to statistical device failures, and indicates reliability of a device. It is the statistical representation of the likelihood of a unit to fail and does not necessarily represent the lifetime of a product.

The MTBF figure is a statistical representation of the likelihood of a device to fail. An MTBF figure of e.g. 1 000 000 h means that statistically one unit out of 10 000 installed units will fail every 100 h. However, it can not be determined if the failed unit has been running for 50 000 h or only for 100 h.

For these types of units the MTTF (**Mean Time To Failures**) value is the same value as the MTBF value.

	AC 230 V	
MTBF SN 29500, IEC 61709	211 000 h	at 24 V, 500 W and +40 °C
	392 000 h	at 24 V, 500 W and +25 °C
MTBF MIL HDBK 217F	88 000 h	at 24 V, 500 W and +40 °C; Ground Benign GB40
	135 000 h	at 24 V, 500 W and +25 °C; Ground Benign GB25
	26 000 h	at 24 V, 500 W and +40 °C; Ground Fixed GF40
	34 000 h	at 24 V, 500 W and +25 °C; Ground Fixed GF25

12. Functional Diagram

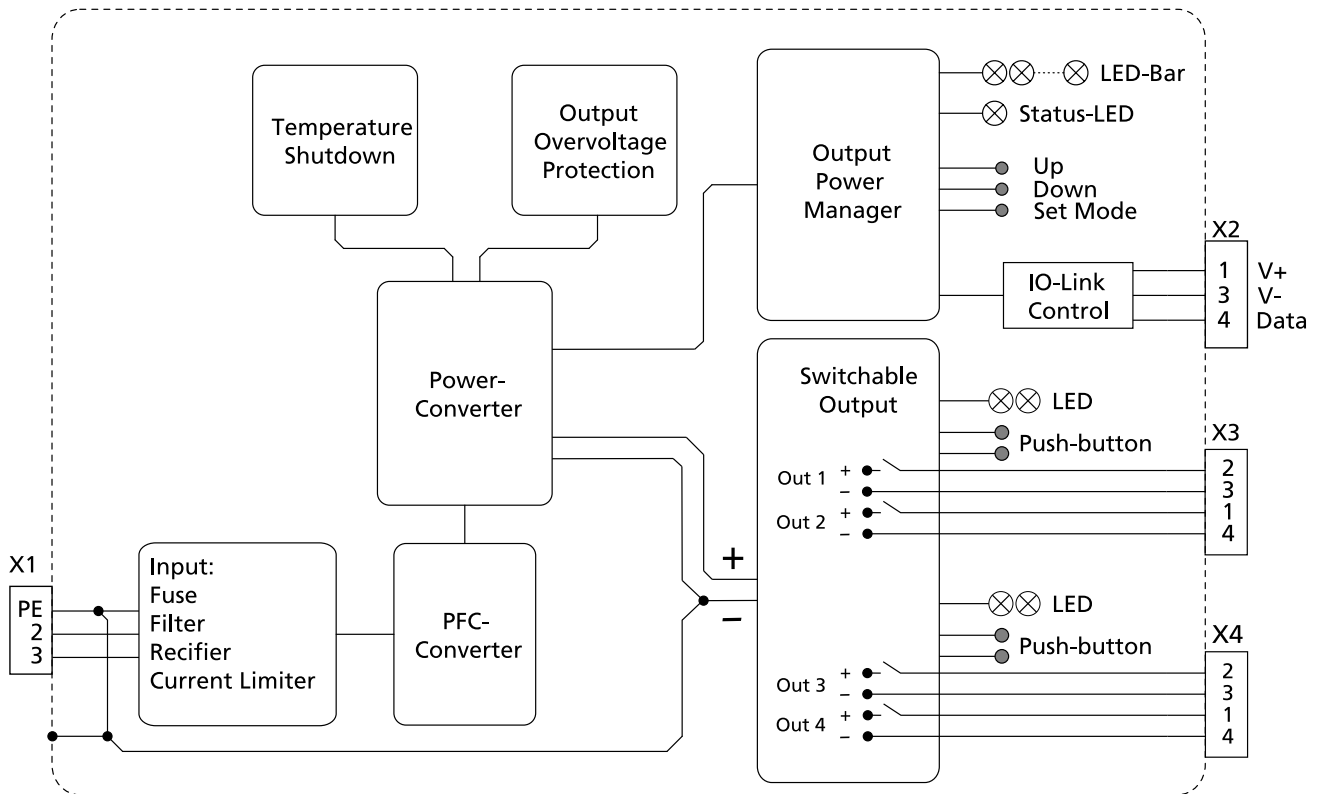
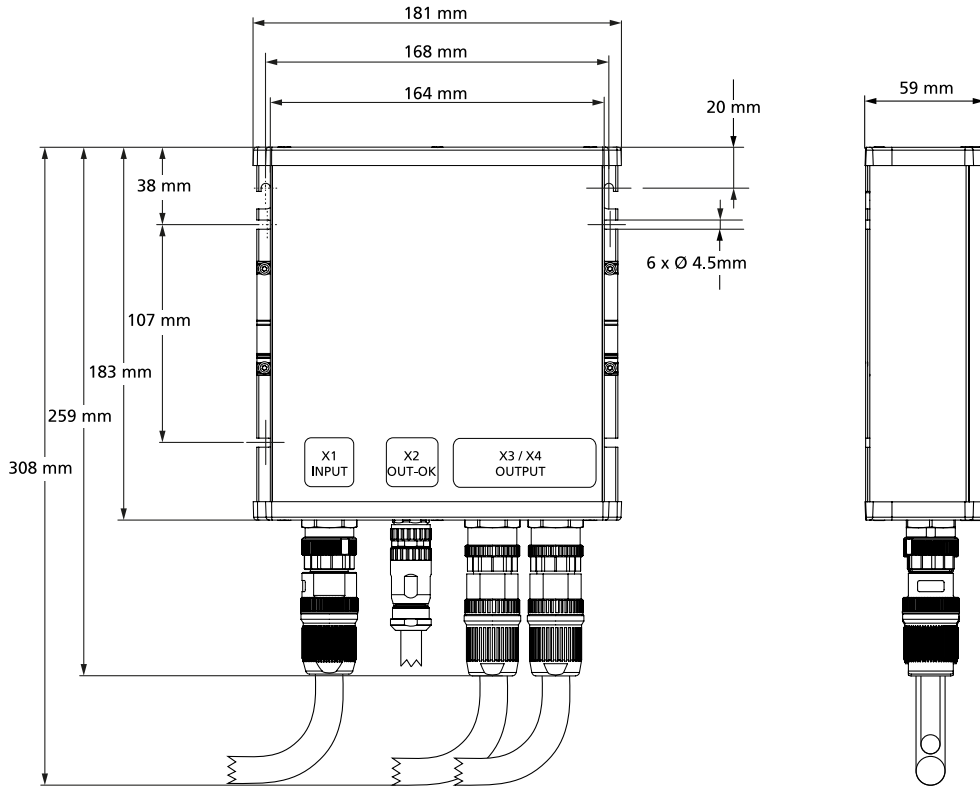

Fig. 12-1: Functional Diagram FPH500.245-047-154

13. Dimensions and Connectors



Width: 181 mm
 Height: 183 mm
 Depth: 59 mm
 Weight: 1200 g

Housing body material: Aluminium alloy
 Housing cover material: Hi-grade polycarbonate
 Installation clearances: See chapter 2

Input connector on power supply (X1):

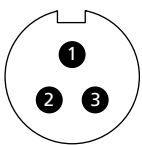

7/8" 3pin male

Pin 1: PE connection \oplus
 Pin 2: L
 Pin 3: N

IO-Link connector on power supply (X2):

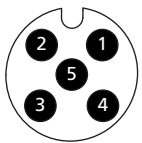

M12-A 5pin male

Pin 1: 24 Vdc
 Pin 2: Not connected
 Pin 3: GND
 Pin 4: Data IN / OUT
 Pin 5: Not connected

Output connector on power supply (X3, X4):

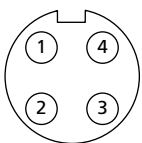

7/8" 4pin female

Pin 1: 24 Vdc (Out 2 | 4)
 Pin 2: 24 Vdc (Out 1 | 3)
 Pin 3: GND (Out 1 | 3)
 Pin 4: GND (Out 2 | 4)

All parameters are specified at 24 V, 500 W, 230 Vac, 25 °C ambient and after a 5 minutes run-in time unless otherwise noted.

14. User Interface

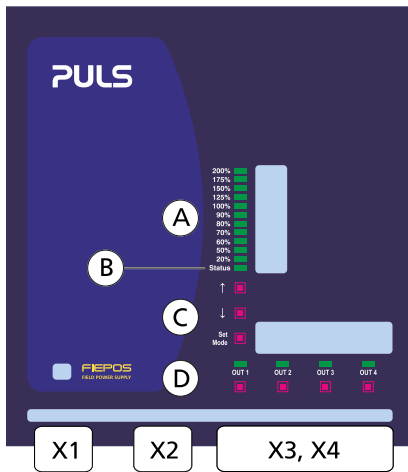

X1	Input connector
X2	IO-Link connector
X3, X4	Output connectors
A	LED bar
B	Status LED
C	Set Mode and UP / DOWN buttons
D	Output channel LEDs & output channel ON / OFF button

Overview

LED bar (A)

The LED bar is a multifunctional display. The main function is to monitor the sum of all outputs (percentages scale). It also can display the output voltage (voltage scale) and output power (percentage scale) for the individual outputs. The integrated status LED displays different running conditions of the device in real-time.

Status LED (B)

The Status LED displays different running conditions of the device in real-time.

Output level controls (C)

The output level controls consist of the Set Mode button and the UP / DOWN buttons. The Set Mode button is used to change into tripping current settings. The UP / DOWN buttons are used to adjust different output levels or change into the output current mode.

Output controls (D)

The output controls consist of an output channel LED and an output channel ON / OFF button for each output. The output channel LED displays different running conditions for output in real-time. The output channel ON / OFF button is to reset the output channel or switch it on / off.

Operation settings

Monitor output power mode

The output power mode displays the actual total output power after startup. It is the default mode of the LED bar. The output power is displayed in percentages of 500 W. If the LED bar is powered up till e.g. 50 %, 250 W is expended. If the LED bar rises above 100 % and therefore exceeds 500 W the 125 %-LED flashes orange. Refer to the percentage scale on the left sidebar.

Monitor output current mode

The output current mode is to check the output current of the individual outputs.

To inspect output currents:

- Press the UP or DOWN button. The LED indicating OUT 1 on the LED bar lights up in orange. Simultaneously, the output current is displayed in real-time in the LED bar above.
- Switch between the different outputs using the UP / DOWN buttons to check the different output current values.
- Return to the output power mode / default mode by pushing beyond the highest or lowest output.

Set tripping current

To set a new tripping current:

- Press Set Mode button for 3 s. The LED bar lights up once and the set voltage is displayed.
- Press Set Mode button to select the right output to change the tripping current. The orange LED will indicate which output is selected.
- Push UP / DOWN button to increase or decrease the set point, see current scale on the right sidebar.
- New point is set.
- After 15 s of non-action, the device will automatically switch to output power mode.

Set output voltage

To set a new output voltage:

- Press Set Mode button for 3 s. The LED bar lights up once and the set voltage is displayed.
- Push UP / DOWN button to increase or decrease the set point, see voltage scale on the right sidebar.
- New point is set.
- After 15 s of non-action, the device will automatically switch to output power mode.

Set button lock

To activate / deactivate the button lock:

- Press the UP / DOWN buttons simultaneously for 3 s. The LED bar will flash for 5 s to indicate the changed button lock status.

Reset output





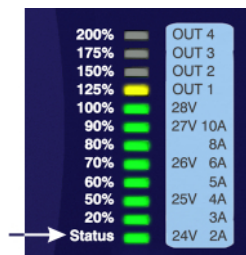

In a failure mode where the output channel is switched off:

- Push and hold the output channel ON / OFF button for more than 1 s.

LED signaling

The Status LED (B) displays different running conditions of the device in real-time.



-  **Green: On**
DC voltage is above 90 % of set point voltage. All outputs are operating according to their settings.
-  **Flashes green: Remote off**
The device turns off due to standby configuration of IO-Link parameter "Standby".
-  **Off**
DC voltage is below 90 % of set point voltage or an output channel has tripped or device is not powered.
-  **Flashes orange: Overcurrent**
Output is off during these 18 s.
-  **Red: AC input failure**
AC input drops below the specified levels and outputs turns off.
-  **Flashes red: Overtemperature**
The unit has turned off due to overtemperature. As soon as the temperature reaches normal operating range the output turns on again and the status LED changes to solid green.

Channel LED Signaling Overview

Output channel LEDs (D)

Below is an overview of the output channel LED signaling.

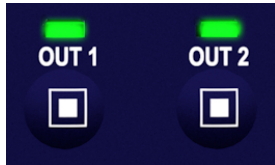

Fig. 14-1: Location of output channels LEDs



Off

Output channel is switched off by ON / OFF button or device is not powered, see status LED.



Green: Default

Output channel is switched on by ON / OFF button.



Flashes green: Power budget tripped

(slow rate: 250 ms on / 250 ms off)

Low priority output channels are tripped. Sum of output currents are above device power budget.



Flashes green: Buttons locked

(fast rate: 125 ms on / 125 ms off)

Button lock is activated. No action is carried out. Unlock buttons by following operation settings > Set Button Lock. Other reason: Button lock is also activated if the channel overheats, e.g. due to rapidly turning the channel on and off.



Orange: Pre-Alarm

Output channel is still running. Current is above pre-alarm level and close to overload.



Flashes orange: Overload

(slow rate: 500 ms on / 500 ms off)

Output channel is tripped. Output current is overloaded. Restart by pushing the ON / OFF button.



Flashes orange: Faulty installation

(medium rate: 250 ms on / 250 ms off)

Output channel will turn off automatically. Cable or connected hardware on the output channels are not installed correctly. Switch off the output channel manually by pushing the specific output channel ON / OFF button.

- Connector negative wire overcurrent according to negative trip curve, or output channel was contributing to negative overcurrent of another output channel ($I_{pos} - I_{neg} > \text{threshold}$), or high PE current ($> 12 \text{ A}$) was detected based on overall output current sum.



Flashes orange: Short circuit

(fast rate: 125 ms on / 125 ms off)

Output channel is tripped. The output current exceeded approx. 48 A. Short circuit reasons may be electrical short, loads beyond specification, plugging-in a large capacitance during operation, etc. After pushing of specific ON / OFF button, output channel tries to turn on.



Flashes orange / green: Overtemperature

(slow rate, 500 ms orange / 500 ms green)

Output channel will turn off automatically when output channel overheats. When internal temperature falls below +90 °C the output channel will turn on automatically.



Red: MOSFET malfunction

Device turns off. Power switch on specific output channel is damaged. Replacement of device might be required.

Possible malfunction:

- Positive output current in off-state exceeds $> 2 \text{ A}$ for more than $> 0.5 \text{ s}$



Flashes red: Hardware specs out of range

(slow rate, 500 ms on / 500 ms off)

Affected output channel turns off. Measurement circuit hardware is out of specified range. Replacement of device might be required.

Possible malfunction:

- Deviations of internal output current sensors exceed acceptable limits.
- Temperature sensor out of range (-40 °C or $+150 \text{ °C}$) for more than 5 s.

15. EMC

The EMC behavior of the device is designed for applications in industrial environment as well as in residential, commercial and light industry environments.

The device is investigated according to EN 61000-6-1, EN 61000-6-2, EN 61000-6-3, EN 61000-6-4, EN 61000-3-2 and EN 61000-3-3.

EMC Immunity*

Electrostatic discharge	EN 61000-4-2	contact discharge	8 kV	Criterion A
Air discharge		air discharge	15 kV	Criterion A
Electromagnetic RF field	EN 61000-4-3	80 MHz - 1 GHz	20 V/m	Criterion A
		1 GHz - 6 GHz	10 V/m	Criterion A
Fast transients (Burst)	EN 61000-4-4	AC input lines	4 kV	Criterion A
		DC output lines	2 kV	Criterion A
		IO-Link	2 kV	Criterion A
Surge voltage on AC input	EN 61000-4-5	L → N	2 kV	Criterion A
		L / N → PE	4 kV	Criterion A
Surge voltage on DC output	EN 61000-4-5	(+) → (-)	1 kV	Criterion A
		(+) / (-) → PE	2 kV	Criterion A
Surge voltage on IO-Link	EN 61000-4-5	IO-Link → PE	1 kV	Criterion A
Conducted immunity	EN 61000-4-6	AC input	20 V	Criterion A
		DC output	20 V	Criterion A
		IO-Link	10 V	Criterion A
Voltage dips	EN 61000-4-11	0 % of 200 Vac	0 Vac, 20 ms	Criterion A
		40 % of 200 Vac	80 Vac, 200 ms	Criterion A
		70 % of 200 Vac	140 Vac, 500 ms	Criterion A
Voltage interruptions	EN 61000-4-11	0 % of 200 Vac	0 Vac, 5000 ms	Criterion C
Voltage sags	SEMI F47	dips on the input voltage according to SEMI F47 standard		
		80 % of 208 Vac	166 Vac, 1000 ms	Criterion A
		70 % of 208 Vac	145 Vac, 500 ms	Criterion A
		50 % of 208 Vac	104 Vac, 200 ms	Criterion A
Powerful transients	VDE 0160	over entire load range	750 V, 0.3 ms	Criterion A

Performance criterions:

A: The device shows normal operation behavior within the defined limits.

C: Temporary loss of function is possible. The device may shut down and restart by itself. No damage or hazards for the device will occur.

*Levels according to EN 61326-1:2013-01 for IO-Link certification immunity have been tested.

EMC Emission

Conducted emission AC input lines	EN IEC 61000-6-3, EN 55032, Class B EN 55011
Conducted emission DC output lines	EN IEC 61000-6-3
Radiated emission	EN IEC 61000-6-3, EN 55032, Class B EN 55011
Harmonics	EN 61000-3-2 pass for Class A equipment
Voltage fluctuations, flicker	EN 61000-3-3 pass tested with constant current loads, non pulsing

This device complies with FCC Part 15 rules.

Operation is subjected to following two conditions: (1) this device may not cause harmful interference, and (2) this device must accept any interference received, including interference that may cause undesired operation.

Switching Frequencies

PFC converter	20 kHz to 135 kHz	input voltage and output load dependent
Main converter	60 kHz to 140 kHz	output load dependent
Auxiliary converter	54 kHz to 66 kHz	output load dependent
Microcontroller clocks	48 MHz and 32 MHz	fixed frequency

16. Environment

Operational temperature	-30 °C to +70 °C	Operational temperature is the same as the ambient or surrounding temperature and is defined as the air temperature 3 cm below the unit.
Storage temperature	-40 °C to +85 °C	for storage and transportation
Output derating	10 W / °C 20 W / 1000 m or 5 °C / 1000 m for altitudes > 2000 m, see Fig. 16-2 The derating is not hardware controlled. The application has to stay below the derated current limits in order not to overload the unit.	between +45 °C and +70 °C, see Fig. 16-1
Humidity	5-95 % r.h.	according to IEC 60068-2-30
Atmospheric pressure	54-110 kPa	see Fig. 16-2
Altitude	up to 5000 m	see Fig. 16-2
Overvoltage category	III	according to IEC 60664-1 for TN-, TT-mains systems with earthed neutral and IT star mains systems with insulation monitoring for altitudes up to 2000 m
	II	according to IEC 60664-1 for TN-, TT-mains systems with earthed neutral and IT star mains systems with insulation monitoring for altitudes between 2000 m and 5000 m according to IEC 60664-1 for TN-, TT-, IT-delta mains systems or IT star mains systems without insulation monitoring for altitudes up to 2000 m
Degree of pollution	3	according to IEC/UL 61010-1
Vibration sinusoidal	2-17.8 Hz: ±1.6 mm; 17.8-500 Hz: 2 g 2 hours / axis	according to IEC 60068-2-6
Shock	30 g 6 ms, 20 g 11 ms 3 bumps / direction, 18 bumps in total	according to IEC 60068-2-27
	Shock and vibration is tested in combination with DIN rails according to EN 60715 with a height of 15 mm and a thickness of 1.3 mm and standard orientation.	
Audible noise	Some audible noise may be emitted from the power supply during no load, overload or short circuit.	

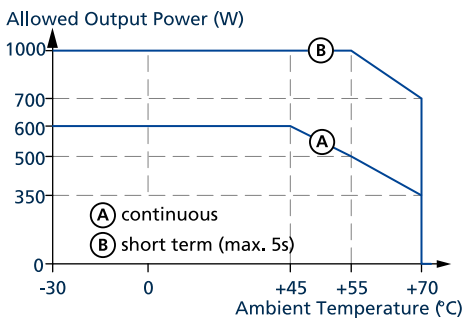

Fig. 16-1: Output power vs. ambient temp.

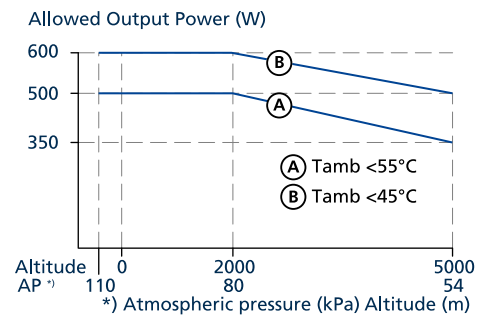

Fig. 16-2: Output power vs. altitude

17. Safety and Protection Features

Isolation resistance	min.	500 MOhm	at delivered condition between input and output, measured with 500 Vdc
	min.	500 MOhm	at delivered condition between input and PE, measured with 500 Vdc
PE resistance	max.	0.1 Ohm	resistance between PE terminal and housing
Input / Output separation		PELV/ES1	IEC/EN/UL 61010-2-201, IEC/EN 62368-1, IEC/EN 60950-1
Output overvoltage protection	typ.	31.8 Vdc	
	max.	32.5 Vdc	In case of an internal defect, a redundant circuit limits the maximum output voltage. The output shuts down and automatically attempts to restart.
Class of protection		I	according to IEC 61140 a PE (Protective Earth) connection is required
Degree of protection		IP65 and IP67	according to EN/IEC 60529
Overtemperature protection		included	Output shut down with automatic restart. Temperature sensors are installed on critical components inside the unit and the unit turns off in safety critical situations, which can happen, e.g. when ambient temperature is too high, ventilation is obstructed or the derating requirements are not followed. There is no correlation between the operating temperature and turn-off temperature since this is dependent on input voltage, load and installation methods.
Input transient protection		MOV (Metal Oxide Varistor)	for protection values, see chapter 15.
Internal input fuse		included	not user replaceable slow-blow high-breaking capacity fuse, 6.3 A (T)
Leakage current	max.	0.49 mA _{rms}	at 264 Vac, 60 Hz, TN-,TT-mains / IT-mains

18. Dielectric Strength

The negative terminals of the outputs are permanently connected to PE within the unit. The output is separated from the input by a double or reinforced insulation.

Type and routine tests are conducted by the manufacturer. Field tests may be conducted in the field using the appropriate test equipment which applies the voltage with a slow ramp (2 s up and 2 s down). Connect all input terminals before conducting the test. When testing, set the cut-off current settings to the value in the table below.

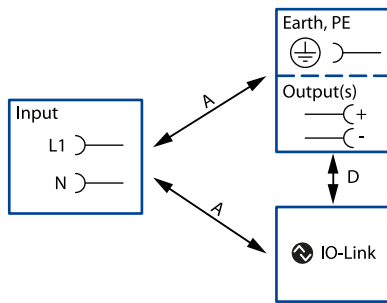





Fig. 18-1: Dielectric strength

		A	D
Type test	60 s	2500 Vac	500 Vac
Routine test	5 s	2500 Vac	500 Vac
Field test	5 s	2000 Vac	500 Vac
Cut-off current setting for field test		> 10 mA	> 10 mA

19. Approved, Fulfilled or Tested Standards

IEC 62368	CB Report	CB Scheme Certificate IEC 62368-1 - Audio / video, information and communication technology equipment - Safety requirements Output safety level: ES1
IEC 61010	CB Report	CB Scheme Certificate IEC 61010-2-201 - Electrical Equipment for Measurement, Control and Laboratory Use - Particular requirements for control equipment
IEC 60950	Safety ✓	Manufacturers Declaration IEC 60950-1 – General safety requirements for Information Technology Equipment (ITE)
UL 61010		UL Certificate Listed equipment for category NMTR - UL 61010-2-201 - Electrical equipment for measurement, control and laboratory use - Particular requirements for control equipment Applicable for US and Canada E-File: E198865
Semi F47	SEMI F47	Test Report Voltage Sag Immunity for Semiconductor Processing Equipment Tested for AC 208 V L-L or L-N mains voltages, nominal output voltage and nominal output load
VDMA 24364	LABS VDMA 24364-C1-L/W	Paint Wetting Impairment Substances Test (or LABS-Test) Tested for Zone 2 and Test Class C1 according to VDMA 24364-C1-L/W for solvents and water-based paints

20. Regulatory Product Compliance

EU Declaration of Conformity		The CE mark indicates conformance with the European <ul style="list-style-type: none"> - EMC directive - Low-voltage directive (LVD) - RoHS directive
WEEE Directive		Manufacturer's Declaration EU-Directive on Waste Electrical and Electronic Equipment (WEEE) registered in Germany as business to business (B2B) products. WEEE-Reg.-Nr. DE 55837529
REACH Regulation (EU)	REACH ✓	Manufacturer's Statement EU regulation regarding the Registration, Evaluation, Authorisation and Restriction of Chemicals (REACH) fulfilled.
RoHS-China		Manufacturer's Statement Administrative Measures for the Restriction of the Use of Hazardous Substances in Electrical and Electronic Products 25 years
IEC/EN 61558-2-16 (Annex BB)	Safety Isolating Transformer	Safety Isolating Transformers corresponding to Part 2-6 of the IEC/EN 61558

21. Accessories

21.1. DIN Rail Mounting Kit: ZM.FPDRA-11

In addition to screw mounting FIEPOS can easily be attached to a DIN rail using the ZM.FPDRA-11 DIN rail mounting kit.

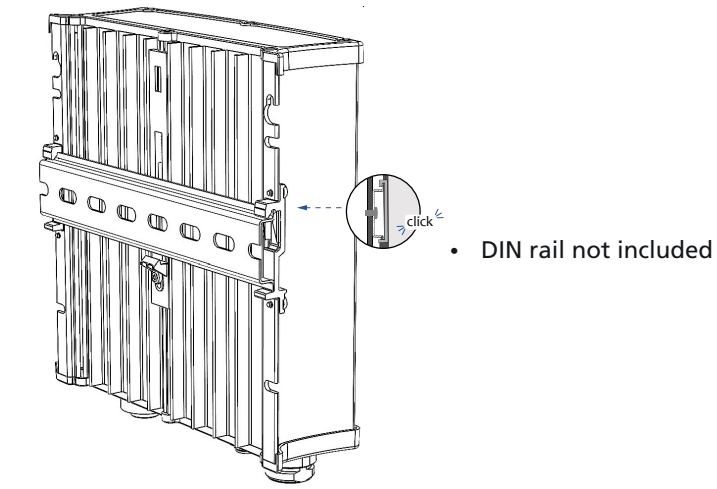

21.2. Mounting Bracket: ZM.FPMBA-11

In addition to screw mounting FIEPOS can easily be attached onto surfaces using the mounting bracket ZM.FPMBA-11.

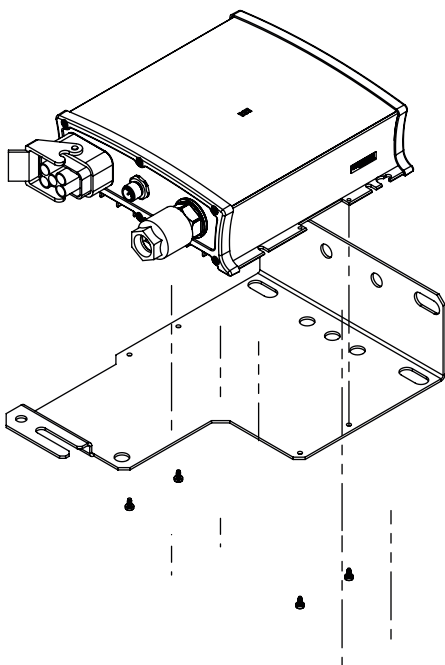

22. Application Notes

22.1. Repetitive Pulse Loading

Typically, a load current is not constant and varies over time. This power supply is designed to support loads with a higher short-term power demand. The short-term duration is hardware controlled by an output power manager and is available on a repeated basis. If the average load is higher than the sum of all output power, the output voltage will dip.

To avoid this, the following rules must be followed:

- a) The power demand of the pulse must be below 200 % of the nominal output power.
- b) The duration of the pulse power must be shorter than the allowed short-term power time, see chapter 6.
- c) The average power should be lower than the nominal output power.

The R.M.S. output current must be below the specified continuous output current. If the R.M.S. current is higher, the unit may respond with a thermal shut-down after a period of time.

22.2. External Input Protection

The device is designed, tested and approved for branch circuits up to 20 A (UL) and 32 A (IEC) without an additional protection device. If an external device (fuse or circuit breaker) is utilized, do not use fuses or circuit breaker smaller than 6 A B- or C-Characteristic to avoid a unintentional tripping.

22.3. Inductive and Capacitive Loads

The power supply is designed to supply any kind of loads, including capacitive and inductive loads. If extreme large capacitors, such as EDLCs (electric double layer capacitors or "UltraCaps") with a capacitance larger than 20 mF are connected to the output, the power supply might charge the capacitor or the output might trip, see chapter 6.

22.4. Back-Feeding Loads

Loads such as decelerating motors and inductors can feed voltage back to the power supply. This feature is also called return voltage immunity or resistance against Back-E.M.F. (Electro **M**agnetic **F**orce).

This power supply is resistant and does not show malfunctioning when a load feeds back voltage to the power supply below 35 V / 4 J. It does not matter whether the power supply is on or off.

22.5. Parallel Use to Increase Output Power

Do not use parallel devices for higher output currents.

22.6. Series Operation

Do not connect power supplies in series.

22.7. Mounting Orientations

The device can be panel mounted in various mounting orientations. The listed lifetime and MTBF values from this datasheet apply only for the standard mounting orientation. The following curves give an indication for allowed output power in different mounting orientations for altitudes up to 2000 m.

A
Standard orientation

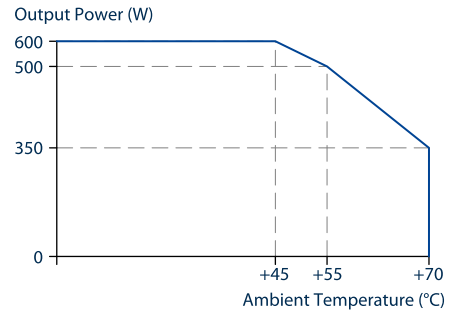
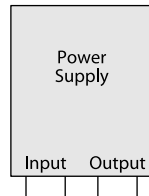

B
Upside down

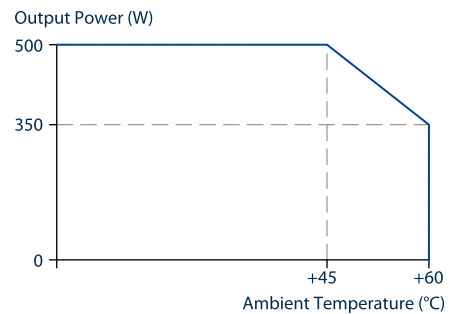
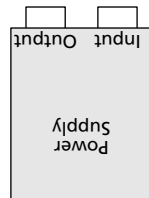

C
Horizontal clockwise
and counter clockwise

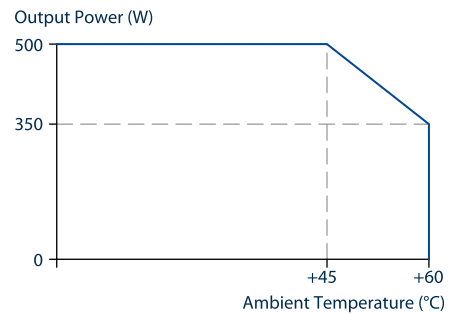

D
Overhead and tabletop
mounting

