



POWER SUPPLY

- 3AC 380-480V wide-range input
- Three input fuses included
- With IO-Link communication interface
- Width only 110mm, weight only 1.5kg
- 95.3% full load and excellent partial load efficiencies
- 50% BonusPower, 1440W for up to 5s
- 100A peak current for 10ms for easy fuse tripping
- Active PFC (power factor correction)
- Active filtering of input transients
- Negligible low input inrush current surge
- Full power between -25°C and +55°C
- Current sharing feature for parallel use
- Remote control of output voltage
- Remote control of shut-down
- 3 Year warranty

PRODUCT DESCRIPTION

The QT40.241-IOL is a high-quality DIN rail power supply based on the popular QT40 series.

Via the integrated IO-Link interface, the unit provides access to real-time and recorded data, informing about the condition of the power supply itself and the power line.

Amongst many electrical operation parameters for advanced diagnostics, event signals are available as well as remote control for shutdown and the "Parallel Use" feature for load sharing between power supplies connected in parallel.

Like its series members, the QT40.241-IOL comes with advanced features. It offers 50% BonusPower, providing large power reserves to support the starting of heavy loads such as DC motors or capacitive loads. High immunity to transients and power surges, as well as low electromagnetic emission, make usage in nearly every environment possible.

SHORT-FORM DATA

Output voltage	DC 24V	nominal
Adjustment range	15 – 28.5Vdc	factory setting 24.1V
Output current	Continuous: 40 - 33.7A 27.5 - 23.2A	up to +55°C ambient at +70°C ambient
	Short-term, up to 5s: 60 - 50.5A	up to +70°C ambient
	Derate linearly between +55°C and +70°C	
Output power	960W 1440W	continuous short term (5s)
Output ripple	< 100mVpp	20Hz to 20MHz
AC Input voltage	3AC 380-480V 3AC 480V	-15%/+10% +20% max. 5sec
Mains frequency	50-60Hz	±6%
AC Input current	1.58 / 1.3A	at 3x400 / 480Vac
Power factor	0.92 / 0.93	at 3x400 / 480Vac
AC Inrush current	typ. 4.5 / 4.5A _{peak}	at 3x400 / 480Vac
Efficiency	95.3 / 95.2%	at 3x400 / 480Vac
Power losses	47.3 / 48.4W	at 3x400 / 480Vac
Temperature range	-25°C to +70°C	operational
Derating	20W/°C	+55°C to +70°C
Hold-up time	typ. 25 / 25ms	at 3x400 / 480Vac
Size (wxhxd)	110x124x143.5mm	without DIN rail
Weight	1500g	

ORDER NUMBERS

Power Supply	QT40.241-IOL	with IO-Link interface
Accessory	ZM2.WALL	Wall mount bracket
	UF20.241	Buffer unit
	YR80.241	Redundancy module

MAIN APPROVALS

For details and the complete approval list, see chapter 22.



UL 61010-2-201

SEMI F47



Semi F47

INDEX

	Page		Page
1. Intended Use	3	23. Regulatory Product Compliance	23
2. Installation Requirements.....	3	24. Physical Dimensions and Weight	24
3. AC Input.....	4	25. Accessories	25
4. Input Inrush Current	5	25.1. ZM2.WALL - Wall mounting bracket.....	25
5. DC Input.....	5	25.2. UF20.241 - Buffer module	25
6. Output	6	25.3. YR80.241 - Redundancy Module.....	26
7. Hold-up Time.....	8	26. Application Notes.....	27
8. IO-Link Interface.....	9	26.1. Repetitive Pulse Loading.....	27
9. Remote Control of Shut-down	13	26.2. Peak Current Capability	28
10. Remote Control of Output Voltage	13	26.3. External Input Protection.....	28
11. Efficiency and Power Losses.....	14	26.4. Using only 2 Legs of a 3-Phase System	29
12. Lifetime Expectancy and MTBF.....	15	26.5. Charging of Batteries	30
13. MTBF	15	26.6. Output Circuit Breakers.....	30
14. Functional Diagram.....	16	26.7. Parallel Use to Increase Output Power....	31
15. Terminals and Wiring.....	17	26.8. Parallel Use for Redundancy	31
16. Front Side and User Elements.....	18	26.9. Series Operation	32
17. EMC.....	19	26.10. Inductive and Capacitive Loads.....	32
18. Environment	20	26.11. Back-feeding Loads	32
19. Protection Features	21	26.12. Use in a Tightly Sealed Enclosure	32
20. Safety Features	21	26.13. Mounting Orientations	33
21. Dielectric Strength	22		
22. Approved, Fulfilled or Tested Standards	23		

The information presented in this document is believed to be accurate and reliable and may change without notice. No part of this document may be reproduced or utilized in any form without permission in writing from the publisher.

TERMINOLOGY AND ABBREVIATIONS

PE and  symbol	PE is the abbreviation for Protective Earth and has the same meaning as the symbol  .
Earth, Ground	This document uses the term "earth" which is the same as the U.S. term "ground".
t.b.d.	To be defined, value or description will follow later.
AC 400V	A figure displayed with the AC or DC before the value represents a nominal voltage with standard tolerances (usually $\pm 15\%$) included. E.g.: DC 12V describes a 12V battery disregarding whether it is full (13.7V) or flat (10V)
400Vac	A figure with the unit (Vac) at the end is a momentary figure without any additional tolerances included.
50Hz vs. 60Hz	As long as not otherwise stated, AC 230V parameters are valid at 50Hz mains frequency.
may	A key word indicating flexibility of choice with no implied preference.
shall	A key word indicating a mandatory requirement.
should	A key word indicating flexibility of choice with a strongly preferred implementation.

1. INTENDED USE

This device is designed for installation in an enclosure and is intended for commercial use, such as in industrial control, process control, monitoring and measurement equipment or the like. Do not use this device in equipment where malfunction may cause severe personal injury or threaten human life without additional appropriate safety devices, that are suited for the end application.

If this device is used in a manner outside of its specification, the protection provided by the device may be impaired. Do not connect the IO-Link port to any other equipment except industrial control equipment.

2. INSTALLATION REQUIREMENTS

⚠ WARNING Risk of electrical shock, fire, personal injury or death.

- Turn power off before working on the device and protect against inadvertent re-powering.
- Do not open, modify or repair the device.
- Use caution to prevent any foreign objects from entering into the housing.
- Do not use in wet locations or in areas where moisture or condensation can be expected.
- Do not touch during power-on, and immediately after power-off. Hot surface may cause burns.

Obey the following installation instructions:

This device may only be installed and put into operation by qualified personnel.

This device does not contain serviceable parts. The tripping of an internal fuse is caused by an internal defect.

If damage or malfunction should occur during installation or operation, immediately turn power off and send unit to the factory for inspection.

Install device in an enclosure providing protection against electrical, mechanical and fire hazards.

Install the device onto a DIN rail according to EN 60715 with the input terminals on the bottom of the device. Other mounting orientations require a reduction in output current.

Make sure that the wiring is correct by following all local and national codes. Use appropriate copper cables that are designed for a minimum operating temperature of +60°C for ambient temperatures up to +45°C, +75°C for ambient temperatures up to +60°C and +90°C for ambient temperatures up to +70°C.

Ensure that all strands of a stranded wire enter the terminal connection. Use ferrules for wires on the input terminals. Unused screw terminals should be securely tightened.

The device is designed for pollution degree 2 areas in controlled environments. No condensation or frost is allowed.

The device is designed for overvoltage category II zones. Below 4000m altitude the device is tested for impulse withstand voltages up to 4kV, which corresponds to OVC III according to IEC 60664-1.

The device is designed as "Class of Protection I" equipment according to IEC 61140. Do not use without a proper PE (Protective Earth) connection.

The device is suitable to be supplied from TN, TT or IT mains networks, grounding of one phase is allowed. The continuous voltage between the input terminals and the PE potential must not exceed 528Vac.

A disconnecting means shall be provided for the input of the device.

The device is designed for convection cooling and does not require an external fan. Do not obstruct airflow and do not cover ventilation grid!

The device is designed for altitudes up to 5000m. Above 2000m a reduction of output current is required. Above 3000m a reduction of overvoltage category is required.

Keep the following minimum installation clearances: 40mm on top, 20mm on the bottom, 5mm left and right side. Increase the 5mm to 15mm in case the adjacent device is a heat source. When the device is permanently loaded with less than 50%, the 5mm can be reduced to zero.

The device is designed, tested and approved for branch circuits up to 32A (IEC) and 30A (UL) without additional protection device. If an external fuse is utilized, do not use circuit breakers smaller than 6A B- or C-Characteristic to avoid a nuisance tripping of the circuit breaker.

The maximum surrounding air temperature is +70°C. The operational temperature is the same as the ambient or surrounding air temperature and is defined 2cm below the device.

The device is designed to operate in areas between 5% and 95% relative humidity.

The supply voltage for the IO-Link must be powered from a PELV or SELV source or an "Isolated Secondary Circuit" in order to maintain a SELV or PELV output.

3. AC INPUT

AC input	nom.	3AC 380-480V	suitable for TN, TT and IT mains networks, grounding of one phase is allowed except in UL 508 applications
AC input range		3x 323-528Vac 3x 528-576Vac	continuous operation short-time operation
Input frequency	nom.	50–60Hz	±6%
Turn-on voltage	typ.	3x 305Vac	steady-state value, load independent, see Fig. 3-1
Shut-down voltage	typ.	3x 275Vac	steady-state value, load independent, see Fig. 3-1

		3AC 400V	3AC 480V	
Input current	typ.	1.58A	1.3A	at 24V, 40A, symmetrical phase voltages, see Fig. 3-3
Power factor ¹⁾	typ.	0.92	0.93	at 24V, 40A, see Fig. 3-4
Start-up delay	typ.	200 - 500ms	200 - 500ms	see Fig. 3-2
Rise time	typ.	80ms	80ms	at 24V, 40A, resistive load, 0mF see Fig. 3-2
	typ.	80ms	80ms	at 24V, 40A, resistive load, 40mF see Fig. 3-2
Turn-on overshoot	max.	500mV	500mV	see Fig. 3-2

1) The power factor is the ratio of the true (or real) power to the apparent power in an AC circuit.

Fig. 3-1 Input voltage range

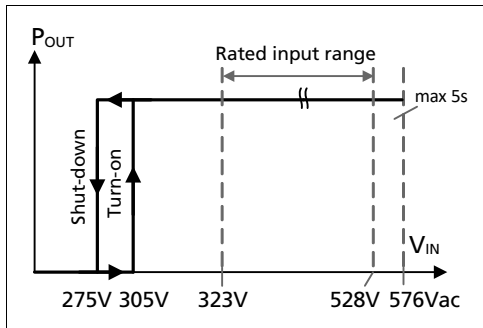

Fig. 3-2 Turn-on behaviour, definitions

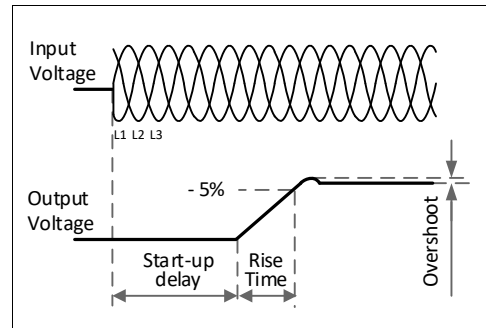

Fig. 3-3 Input current vs. output load at 24V

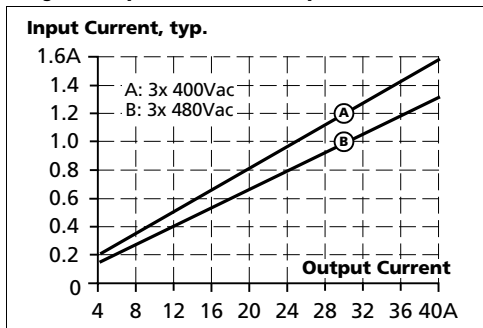
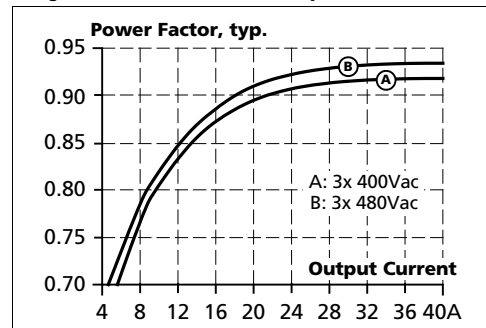

Fig. 3-4 Power factor vs. output load at 24V



4. INPUT INRUSH CURRENT

The power supply is equipped with an active inrush current limitation circuit, which limits the input inrush current after turn-on to a negligible low value. The input current is usually smaller than the steady state input current.

		3AC 400V	3AC 480V	
Inrush current ¹⁾	max.	6A _{peak}	6A _{peak}	over entire temperature range
	typ.	4.5A _{peak}	4.5A _{peak}	over entire temperature range
Inrush energy	max.	1.5A ² s	1.5A ² s	over entire temperature range
Inrush delay	typ.	500ms	600ms	

1) The charging current into EMI suppression capacitors is disregarded in the first microseconds after switch-on.

Fig. 4-1 Typical turn-on behaviour at nominal load and +25°C ambient temperature

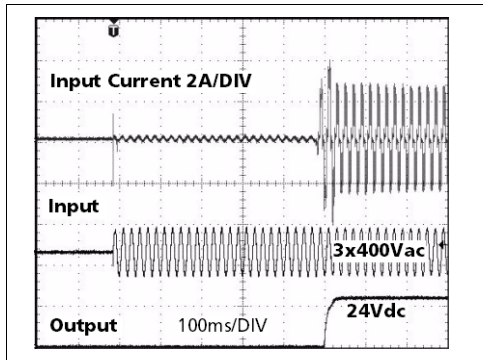

5. DC INPUT

Do not operate this power supply with DC input voltage.

6. OUTPUT

Output voltage	nom.	24V	
Adjustment range		15-28.5V	guaranteed
Factory setting	typ.	24.1V	±0.2%, at full load, cold unit
	typ.	24.1V	±0.2%, at full load, cold unit, in "parallel use" mode
	typ.	25.1V	at no load, cold unit, in "parallel use" mode
Line regulation	max.	10mV	3x 323-576Vac
Load regulation	max.	50mV	static value, 0A→40A, see Fig. 6-1
	typ.	1000mV	in "parallel use" mode: static value, 0A→40A, see Fig. 6-2
Ripple and noise voltage	max.	120mVpp	20Hz to 20MHz, 50Ohm
Output current	nom.	40A	continuously available at 24V, see Fig. 6-1 and Fig. 6-2
	nom.	33.7A	continuously available at 28.5V, see Fig. 6-1 and Fig. 6-2
	nom.	60A	short term (5s) available BonusPower ¹⁾ , at 24V, see Fig. 6-1, Fig. 6-2 and Fig. 6-3
	nom.	50.5A	short term (5s) available BonusPower ¹⁾ , at 28.5V, see Fig. 6-1, Fig. 6-2 and Fig. 6-3
	typ.	100A	up to 10ms, output voltage stays above 20V, see Fig. 6-3, This peak current is available once every second. See chapter 26.2 for more peak current measurements.
Output power	nom.	960W	continuously available at 24-28.5V
	nom.	1440W	short term available BonusPower ¹⁾ at 24-28.5V
BonusPower time	typ.	5s	duration until the output voltage dips, see Fig. 6-2
BonusPower recovery time	typ.	10s	overload free time to reset power manager, see Fig. 6-4
Overload behaviour		continuous current	see Fig. 6-1
Short-circuit current ²⁾	min.	40A	continuous, load impedance 25mOhm, see Fig. 6-1
	max.	44A	continuous, load impedance 25mOhm, see Fig. 6-1
	min.	60A	short-term (5s), load impedance 25mOhm, see Fig. 6-1
	max.	68A	short-term (5s), load impedance 25mOhm, see Fig. 6-1
	typ.	46A	continuous, load impedance <10mOhm
	max.	51A	continuous, load impedance <10mOhm
	typ.	190A	up to 10ms, load impedance <10mOhm, see Fig. 6-4
Output capacitance	typ.	10 200µF	included in the power supply

1) **BonusPower, short term power capability (up to typ. 5s)**

The power supply is designed to support loads with a higher short-term power requirement without damage or shutdown. The short-term duration is hardware controlled by an output power manager. This BonusPower is repeatedly available. Detailed information can be found in chapter 26.1. If the power supply is loaded with the BonusPower longer than shown in the bonus-time diagram (see Fig. 6-2), the max. output power is automatically reduced to 960W.

2) Discharge current of output capacitors is not included.

Fig. 6-1 **Output voltage vs. output current in "single use" mode, typ.**

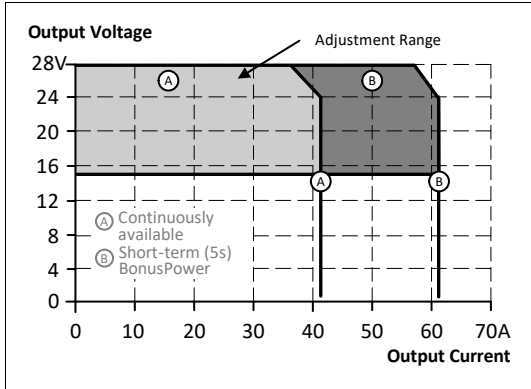

Fig. 6-2 **Output voltage vs. output current in "parallel use" mode, typ.**

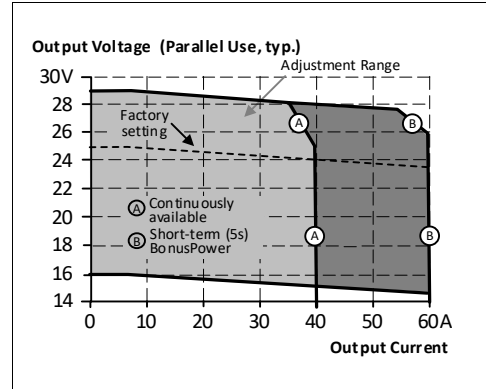

Fig. 6-3 **Bonus time vs. output power**

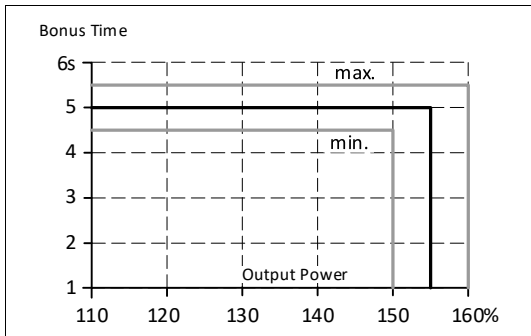

Fig. 6-4 **Dynamic overcurrent capability, typ.**

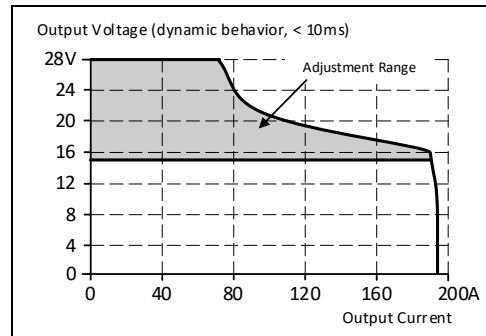
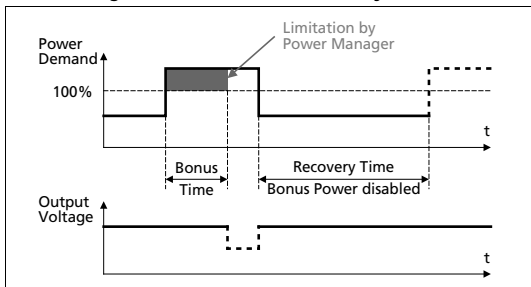

Fig. 6-5 **BonusPower recovery time**



The BonusPower is available as soon as power comes on and after the end of an output short circuit or output overload.

Fig. 6-6 **BonusPower after input turn-on**

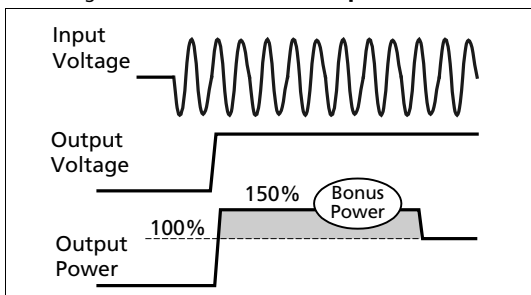
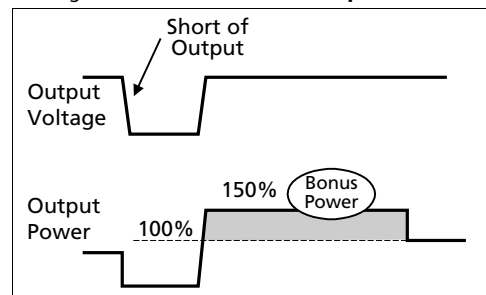

Fig. 6-7 **BonusPower after output short**



7. HOLD-UP TIME

		3AC 400V ¹⁾	3AC 480V ¹⁾	
Hold-up Time	typ.	50ms	50ms	at 24V, 20A, see Fig. 7-1
	min.	40ms	40ms	at 24V, 20A, see Fig. 7-1
	typ.	25ms	25ms	at 24V, 40A, see Fig. 7-1
	min.	20ms	20ms	at 24V, 40A, see Fig. 7-1

1) Curves and figures for operation on only 2 legs of a 3-phase system can be found in chapter 26.4.

Fig. 7-1 Hold-up time vs. input voltage

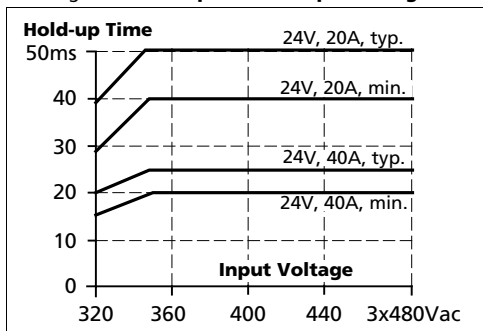
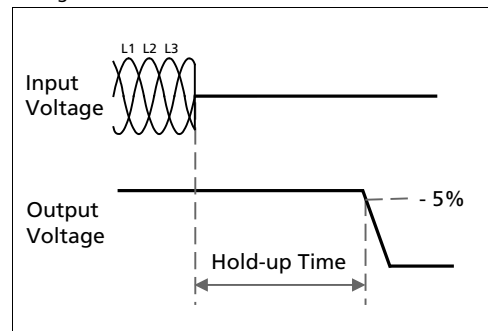

Fig. 7-2 Shut-down behaviour, definitions



8. IO-LINK INTERFACE

This power supply is equipped with an IO-Link interface compliant to IO-Link protocol V1.1 (M12 male, A-coded) on the device front side and can be connected to any IO-Link-masters compliant to V1.1 of IO-Link protocol. The Pin Assignment is shown in Fig. 8-1.

It is possible to operate the power supply without IO-Link communication. Due to a built-in EEPROM, the power supply can also be operated with values which have previously been updated via IO-Link also in case of no IO-Link-master is connected or in case of defective IO-Link connection.

Via IO-Link the power supply can communicate current status, in-/output values and it is also possible to configure the output voltage (see chapter 10 Remote Control of Output Voltage) as well as to remotely shut-down the power supply (described in chapter 9 Remote Control of Shut-down) and switch between single and parallel operation (see chapter 25.7 / 25.8).

Fig. 8-1 IO-Link Interface Pin Assignment

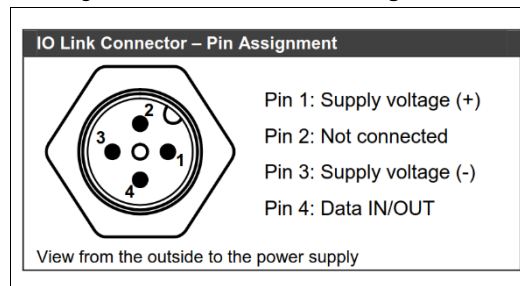

To operate the IO-Link interface it is necessary to install/upload the IODD-File (IO-Link Device Description) to the connected IO-Link master. The most recent IODD file can be found on IODDfinder (<https://ioddfinder.io-link.com>) or on the PULS website (www.pulspower.com) in the download section of the product page of QT40.241-IOL. The device can also be accessed via IO-Link, if the power supply is not connected to AC-mains and in a switched off mode.

IO-Link version	V1.1	To get full performance, it is recommended to use IO-Link-masters with V1.1
Bit rate	COM3 (230.4 kBaud)	
Minimum cycle time	2ms	Cycle time refers to the process data communication speed
SIO-Mode support	no	
Process data length	48bit, 6byte	

The power supply provides three types of data via IO-Link.

Process data

Process data refers to data that is periodically sent to the IO-Link-master. The length is 6Byte and the data is communicated every 2ms. All other data in the power supply itself is generated every 50ms and stored in the IO-Link registers.

Parameter values

The parameter values can be accessed to read out additional data (e.g. operating time, temperatures etc.), but in addition some of these values can also be written by the user to configure the power supply (e.g. output voltage and remote on/off).

Events

This information is triggered by certain situations and will result in an event notification to the IO-Link-master. Typical events are notification in case of ideal (e.g. DC-OK) and non-ideal situations (e.g. ambient temperature too hot, high input voltage etc.).

Aug. 2024 / Rev. 1.0 DS-QT40.241-IOL-EN

All parameters are specified at 24V, 40A, 3x400Vac, +25°C ambient and after a 5 minutes run-in time unless otherwise noted.

All data types used in QT40.241-IOL are listed and described in the following. For additional information on remote shut-down as well as output voltage adjustment, please refer to chapter 9 and 10.

Cyclic Data – Process Data

Output current (A)	Output current value (2 Bytes) between 0-80A to monitor current load attached to the power supply with an accuracy of 800mA. This value is updated to the IO-Link-master every 2ms.
Output voltage (V)	Output voltage value (2 Bytes) between 0-40V to monitor the output voltage with an accuracy of 300mV. This value is updated to the IO-Link-master every 60ms.
Input voltage (Vrms)	Input voltage value (2 Bytes) between 0-1130V to monitor the input voltage with an accuracy of 12V. This value is updated to the IO-Link-master every 60ms.

Acyclic Data – Parameters

Function tag	User specific number or text with a maximum of 32 bytes (R/W)
Location tag	User specific number or text with a maximum of 32 bytes (R/W)
User specific marking	User specific number or text with a maximum of 32 bytes (R/W)
Output voltage setpoint	Adjustment value of output voltage (V), pre-set to 24.1V; This value is stored in the EEPROM of the power supply. In case of no IO-Link communication, the power supply remains to the adjusted output voltage. Only update this data when the power is running and there is an active connection to the IO-Link-master (R/W). For additional information regarding remote control of output voltage, see chapter 10.
Stress level	Average value in (%); The stress level is calculated between output current in relation to the maximum allowed output current. (read-only)
Remaining life time	Estimated lifetime in percent (%); based on the power supply's capacitor temperature, this percentage value decreases over time and can be used for preventive maintenance. High capacitor temperatures accelerate the decrease of lifetime. Please note, that an expired life time does not indicate a break-down of a power supply, but it indicates, that wear-out and aging might impact the originally specified values. (read-only)
Temperature airflow	Incoming air temperature (°C) between -45°C to +150°C; the power supply is equipped with a thermal sensor on the bottom of the device. Since this product is convection cooled, this value gives an indication of the ambient air temperature. To use this feature, it is mandatory to mount the device in an upright position (orientation A), as explained in chapter 26.13. Other mounting orientations might be subject to high temperature warnings as described in the section "events". (read-only)
Max. temperature airflow	Recorded maximum temperature (°C) between -45°C to +150°C since last turn on of power supply (read-only)
Temperature primary inside	Component temperature (°C) on the primary side inside the power supply; values between -45°C to +150°C (read-only)
Max. temperature primary inside	Recorded maximum temperature on the primary side inside the power supply since last turn on; value between -45°C to +150°C (read-only)
Operating time	Cumulated overall operating time in hours (h) stored in power supply's EEPROM; maximum value: 262800h = 30 years (read-only)

Operating time	Cumulated overall operating time in minutes (min) stored in power supply's EEPROM; maximum value: 59min (read-only)
Transient counter overall	Overall amount of significant input transients, that are detected by the power supply's input stage; Maximum value: 7200000 (read-only)
Transient counter last 2 minutes	Overall amount of significant input transients, that are detected by the power supply's input stage; Maximum value: 7200000 (read-only)
Actual input voltage	RMS value of input voltage (V); maximum value: 1130V (read-only)
Actual output voltage	Value of the actual output voltage (V); maximum value: 40V This value shows the actual output voltage and can be used to detect feedback voltages in the DC grid. If the actual output voltage is higher than the adjusted output voltage of the power supply, a back-feeding load is active. (read-only)
Turn-on counter	Cumulated number of power supply turn-ons; this value is stored in the EEPROM of the power supply. Maximum value: 7200000 (read-only)
Uptime since last turn-on	Operating time in hours (h) since last power supply bootup; Maximum value: 1000000 (read-only)
Uptime since last turn-on	Operating time in minutes (min) since last power supply bootup Maximum value: 59 (read-only)
EEPROM Status	"0": EEPROM ok "1": Recoverable error → reset to factory setting "2": Unrecoverable error → contact support
Shut down	A logic "1" turns output off and a logic "0" turns on the output again. Please refer to chapter 9 for further information to shut-down the power supply output. To use this feature it is essential not to power the IO-Link-master from the power supply, which has received a remote shut-down signal. (R/W)
Parallel mode enabled	"0": Single mode of power supply enabled (factory setting) "1": Parallel mode of power supply enabled; Automated load regulation between two separate power supplies; Set all output voltages to the same value. (s. chapter Application Notes) (R/W)

Acyclic Data – Events

DC-OK	As soon as the output voltage reaches 90% of the adjusted output voltage.
DC Warning	As soon as the output voltage dips more than 10% below the adjusted output voltage. Short dips will be extended to a signal length of 250ms. Dips shorter than 1ms will be ignored.
BonusPower	Power supply provides BonusPower and the output current >105%, please see Fig. 6-1
Over temperature (capacitors)	Temperature of capacitors is too high; operating the power supply with hot capacitors decreases the lifetime of the power supply. Please review ambient temperature (airflow temperature) and/or cross check load profile.
Over temperature (airflow)	Inside air temperature sensor detects a too high temperature; it is mandatory to mount the device in an upright position (orientation A), as explained in chapter 26.13. Other mounting orientations might be subject to misleading high temperature warnings.

Overload	Device operates in current limiting mode, please see Fig. 6-1. The current is limited actively to 40A (24V reference). Please check wiring on connection resistance and/or review load's power demand.
High voltage on input	Input voltage above the specified value of 576Vac; please check application on the input of power supply.
Low voltage on input	Input voltage below the specified value of 323Vac; please check application on the input of power supply.
Power supply down	Input power supply failures; this event is triggered, if the communication board lost connection to the power supply controller. It indicates an AC power down or a defective power supply. Please refer to log events in the master/PLC to find information on the root cause (e.g. low input voltage) and check if other events (e.g. high temperature warnings) have been active. The events are not logged in the power supply, so it is recommended to log events in the master/PLC.
Predictive maintenance recommended	Operating hours exceeded the calculated lifetime hours; this event recommends preventive exchange of the power supply. Please note, that an expired life time does not indicate a breakdown of a power supply, but it indicates, that wear-out and aging might impact the originally specified values.
2-Phase operation	Indicates a missing leg of the 3-phase if unit is loaded with more than 20A, see chapter Using only 2 Legs of a 3-Phase System 26.4; please check input wiring and if intended 2-Phase operation, please note reduced performance as described in chapter 26.4.
Humidity	Humidity too high or water condensation on power supply; To avoid personal injury, turn off the power before checking the condition of power supply. To avoid severe condensation damage, ensure the environmental requirements in chapter 17.

9. REMOTE CONTROL OF SHUT-DOWN

To use this feature it is essential not to power the IO-Link-master from the power supply, which is subject to remote shut-down itself. Please assure an independent power supply for the IO-Link-master according to the specification of the master (e.g. 8-port IO-Link-masters can typically be operated with PULS PIM90.241 or CP5.241 or CT5.241) and do use the IO-Link power supply QT40.241-IOL only for powering the load lines.

This feature allows a switch-off of the output of the power supply with a logic "1" in the acyclic parameter data set "Shut down", described in chapter 8. The shut-down occurs immediately while the turn-on is delayed up to 350ms. In a shut-down condition, the output voltage is <2V and the output power is <0.5W.

There are two typical use cases for remote shut-down of the device:

A. Energy Saving

Input	380Vac	480Vac	
Power losses	1.5W	1.5W	with activated shut-down
	9.5W	9.8W	at 24V, 0A (no load)

Using remote shut-down will therefore result in a saving of 8.3W. Assuming 8 hours of downtime every workday, this feature can generate a saving of $8h \cdot 5 \cdot 4 \cdot 8.3W = 1.33kWh$ per month and per power supply.

B. Maintenance

In case of maintenance situation, where loads have to be disconnected but sensor voltages have to stay available, the remote shut-down function can be used. Please note, that the communication protocol is IO-Link V1.1 and not IO-Link Safety; for safety relevant shut-downs, it is prohibited to use this function.

10. REMOTE CONTROL OF OUTPUT VOLTAGE

The standard pre-set value of the output voltage is 24.1V, but the power supply can be set to any output voltage between 15V to 28.5Vdc via IO-Link using the acyclic parameter data set "Output voltage setpoint" as mentioned in chapter 8. The pre-set value is stored in the EEPROM of the power supply, so that the power supply keeps the adjusted output voltage also in case of no IO-Link communication or if the power supply is disconnected from AC-mains. Only update this data when the system is running and there is an active connection to the IO-Link-master.

Please be aware, that repeatedly changing the output voltage of more than 4V reduces the lifetime. We recommend not adjusting the output voltage more than 50 times per day when the adjustment is larger than 4V.

11. EFFICIENCY AND POWER LOSSES

Efficiencies for 3-phase operation:

		3AC 400V	3AC 480V	
Efficiency	typ.	95.3%	95.2%	at 24V, 40A
Average efficiency ¹⁾	typ.	94.7%	94.6%	25% at 10A, 25% at 20A, 25% at 30A, 25% at 40A
Power losses	typ.	1.5W	1.5W	with activated shut-down
	typ.	9.5W	9.8W	at 24V, 0A (no load)
	typ.	24.1W	25.0W	at 24V, 20A (half load)
	typ.	47.3W	48.4W	at 24V, 40A (full load)

1) The average efficiency is an assumption for a typical application where the power supply is loaded with 25% of the nominal load for 25% of the time, 50% of the nominal load for another 25% of the time, 75% of the nominal load for another 25% of the time and with 100% of the nominal load for the rest of the time.

Efficiencies when using only 2 legs of a 3-phase system:

		2AC 400V	2AC 480V	
Efficiency	typ.	94.4% ²⁾	94.7% ²⁾	at 24V, 40A
Power losses	typ.	56.9W ²⁾	53.7W ²⁾	at 24V, 40A (full load)

2) Curves can be found in chapter 26.4

Fig. 11-1 **Efficiency vs. output current at 24V, typ.**

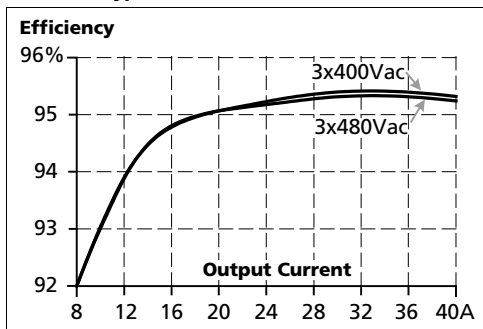

Fig. 11-2 **Losses vs. output current at 24V, typ.**

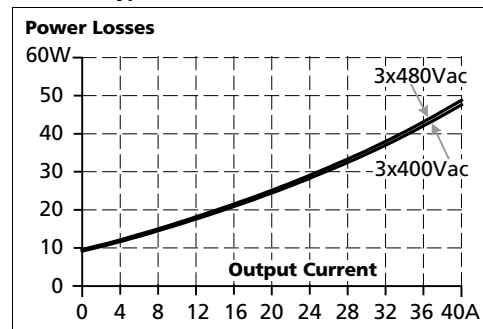

Fig. 11-3 **Efficiency vs. input voltage at 24V, 40A, typ.**

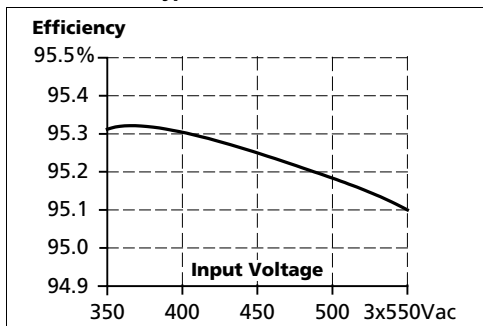
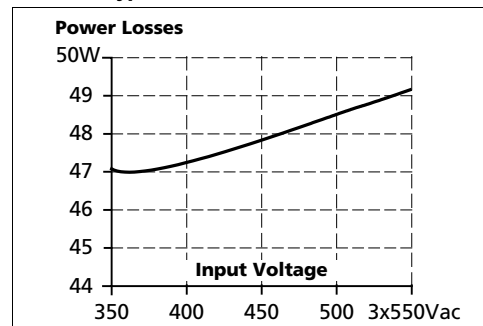

Fig. 11-4 **Losses vs. input voltage at 24V, 40A, typ.**



12. LIFETIME EXPECTANCY AND MTBF

The **calculated lifetime expectancy** shown in the table indicates the minimum operating hours (service lifetime) and is determined by the lifetime expectancy of the built-in electrolytic capacitors. Lifetime expectancy is specified in operational hours and is calculated according to the capacitor's manufacturer specification. The manufacturer of the electrolytic capacitors only guarantees a maximum lifetime of up to 15 years (131 400h). Any number exceeding this value is a calculated theoretical lifetime which can be used to compare devices.

	3AC 400V	3AC 480V	
Calculated lifetime expectancy	62 000h	62 000h	at 24V, 40A and +40°C
	78 000h	76 000h	at 24V, 32A and +40°C
	112 000h	109 000h	at 24V, 20A and +40°C
	172 000h	172 000h	at 24V, 40A and +25°C
	221 000h	212 000h	at 24V, 32A and +25°C
	304 000h	288 000h	at 24V, 20A and +25°C

13. MTBF

MTBF stands for Mean Time Between Failures, which is calculated according to statistical device failures, and indicates reliability of a device. It is the statistical representation of the likelihood of a unit to fail and does not necessarily represent the life of a product.

The MTBF figure is a statistical representation of the likelihood of a device to fail. A MTBF figure of e.g. 1 000 000 h means that statistically one unit will fail every 100 h if 10 000 units are installed in the field. However, it cannot be determined if the failed unit has been running for 50 000 h or only for 100 h.

For these types of units the MTTF (Mean Time To Failure) value is the same value as the MTBF value.

	3AC 400V	3AC 480V	
MTBF SN 29500, IEC 61709	350 000h	345 000h	at 24V, 40A and +40°C
	628 000h	622 000h	at 24V, 40A and +25°C
MTBF MIL HDBK 217F	90 000h	90 000h	at 24V, 40A and +40°C; Ground Benign GB40
	120 000h	119 000h	at 24V, 40A and +25°C; Ground Benign GB25
	28 000h	28 000h	at 24V, 40A and +40°C; Ground Fixed GF40
	37 000h	36 000h	at 24V, 40A and +25°C; Ground Fixed GF25

14. FUNCTIONAL DIAGRAM

Fig. 14-1 Functional diagram

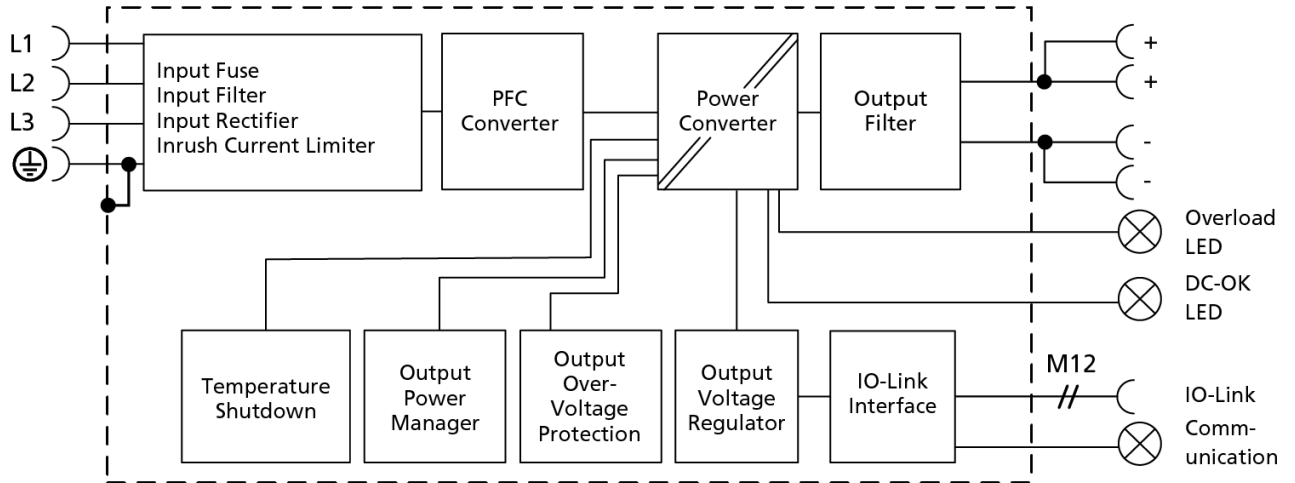

15. TERMINALS AND WIRING

The terminals are IP20 Finger safe constructed and suitable for field and factory wiring.

Type	Input	Output	IO-Link
	screw terminals	screw terminals	A-coded M12 male
Solid wire	max. 6mm ²	max. 16mm ²	-
Stranded wire	max. 4mm ²	max. 10mm ²	-
American Wire Gauge	AWG 20-10	AWG 22-8	-
Max. wire diameter	2.8mm (including ferrules)	5.2mm (including ferrules)	-
Wire stripping length	7mm	12mm	-
Screwdriver	4mm slotted or cross-head No 1	3.5mm or 5mm slotted or cross-head No 2	screw-nut might require wrench
Recommended tightening torque	0.8Nm	2Nm	0.6Nm

Instructions:

- a) Use appropriate copper cables that are designed for minimum operating temperatures of:
 - +60°C for ambient up to +45°C and
 - +75°C for ambient up to +60°C minimum
 - +90°C for ambient up to +70°C minimum.
- b) Follow national installation codes and installation regulations!
- c) Ensure that all strands of a stranded wire enter the terminal connection!
- d) Do not use the unit without PE connection.
- e) Unused terminal compartments should be securely tightened.
- f) Ferrules are allowed.

Daisy chaining:

Daisy chaining (jumping from one power supply output to the next) is allowed as long as the average output current through one terminal pin does not exceed 54A. If the current is higher, use a separate distribution terminal block as shown in Fig. 15-2.

Fig. 15-1 Daisy chaining of outputs

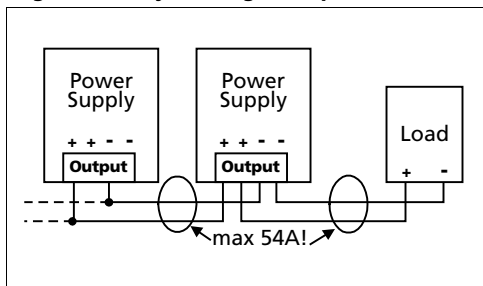
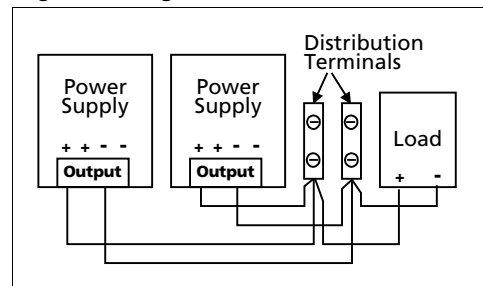
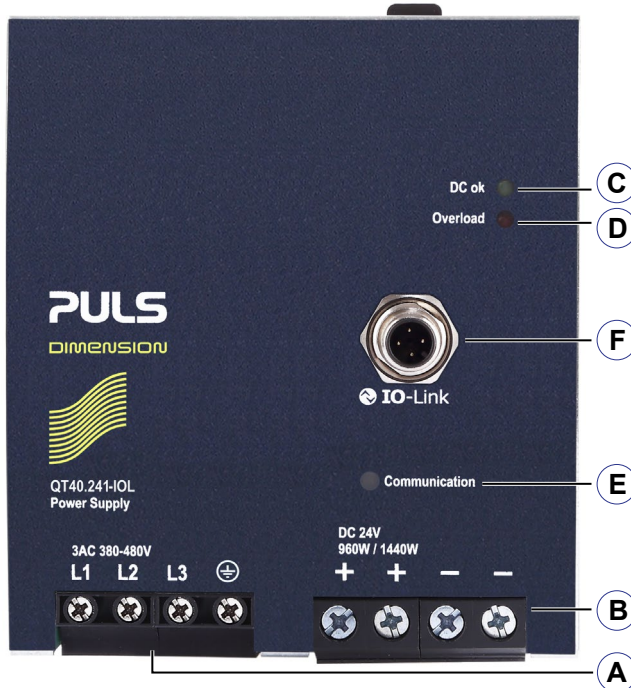

Fig. 15-2 Using distribution terminals



16. FRONT SIDE AND USER ELEMENTS

Fig. 16-1 Front side



- A Input Terminals** (Screw terminals)
L1, L2, L3 Line input
 ...PE (Protective Earth) input
- B Output Terminals**
 (Screw terminals, two pins per pole)
 + Positive output
 - Negative (return) output
- C DC-OK LED** (green)
 On, when the voltage on the output terminals is >90% of the adjusted output voltage
- D Overload LED** (red)
 - On, when the voltage on the output terminals is <90% of the adjusted output voltage, or in case of a short circuit in the output.
 - Flashing, when the shut-down has been activated or the unit has switched off due to overtemperature.
 - Input voltage is required
- E IO-Link Communication LED** (green/red)
 - OFF, when IO-Link not powered
 - Green on, when IO-Link interface powered
 - Green flashing, when communication active
 - Red on, when IO-Link warning event triggered
 - Red flashing, when notification active
- F IO-Link Connector** M12 A-coded male

Indicators, LEDs

	Overload LED	DC-OK LED	IO-Link Communication LED
Normal mode	OFF	ON	
During BonusPower	OFF	ON	
Overload (Vout < 90%)	ON	OFF	
Output short circuit	ON	OFF	
Temperature Shut-down	flashing	OFF	
Active Shut-down input	flashing	OFF	
No input power	OFF	OFF	
No IO-Link power			OFF
IO-Link interface powered			Green ON
IO-Link communication active			Green flashing
IO-Link warning event triggered			Red ON
IO-Link event / notification activated			Red flashing

17. EMC

A detailed EMC report is available on request. The power supply is suitable for applications in industrial environment. All results assume a three phase operation of the power supply.

EMC Immunity		According generic standards: EN IEC 61000-6-2		
Electrostatic discharge	EN 61000-4-2	contact discharge air discharge	8kV 15kV	Criterion A Criterion A
Electromagnetic RF field	EN 61000-4-3	80MHz - 6GHz	10V/m	Criterion A
Fast transients (Burst)	EN 61000-4-4	input lines output lines IO-Link signal lines (coupling clamp)	4kV 2kV 2kV	Criterion A Criterion A Criterion A
Surge voltage on input	EN 61000-4-5	L1 → L2, L2 → L3, L1 → L3 L1 / L2 / L3 → PE	2kV 4kV	Criterion A Criterion A
Surge voltage on output	EN 61000-4-5	+ → - + / - → PE	1kV 1kV	Criterion A Criterion A
Conducted disturbance	EN 61000-4-6	0.15-80MHz	10V	Criterion A
Mains voltage dips (Dips on three phases)	EN 61000-4-11	0% of 380Vac (0Vac) 0% of 480Vac (0Vac)	0Vac, 20ms 0Vac, 20ms	Criterion A, Criterion A
Mains voltage dips (Dips on two phases)	EN 61000-4-11	40% of 380Vac (152Vac) 40% of 480Vac (192Vac) 70% of 380Vac (266Vac) 70% of 480Vac (336Vac)	200ms 200ms 500ms 500ms	Criterion A Criterion A Criterion A Criterion A
Voltage interruptions	EN 61000-4-11	0Vac	5000ms	Criterion C
Voltage sags	SEMI F47	dips on two phases according to section 7.2. of the SEMI F47 standard 80% of 380Vac (304Vac) 70% of 380Vac (266Vac) 50% of 380Vac (160Vac)	1000ms 500ms 200ms	Criterion A Criterion A Criterion A
Powerful transients	VDE 0160	over entire load range	1550V, 1.3ms	Criterion A

Criteria:

A: Power supply shows normal operation behavior within the defined limits.

C: Temporary loss of function is possible. Power supply may shut-down and restarts by itself. No damage or hazards for the power supply will occur.

EMC Emission		According generic standards: EN IEC 61000-6-4; EN IEC 61000-6-8	
Conducted emission input lines	EN 55011, EN 55032, FCC Part 15, CISPR 11, CISPR 32	Class B	
Conducted emission output lines	IEC/CISPR 16-1-2, IEC/CISPR 16-2-1	limits for DC power ports according EN IEC 61000-6-8 are fulfilled	
Radiated emission	EN 55011, EN 55032	Class A	
Harmonic input current	EN 61000-3-2	fulfilled for class A equipment	
Voltage fluctuations, flicker	EN 61000-3-3	fulfilled ¹⁾	

This device complies with FCC Part 15 rules.

Operation is subjected to following two conditions: (1) this device may not cause harmful interference, and (2) this device must accept any interference received, including interference that may cause undesired operation.

1) Tested with constant current loads, non-pulsing

Switching Frequencies	The power supply has three converters with three different switching frequencies included. One is nearly constant. The others are variable.	
Switching frequency 1	105kHz	resonant converter, nearly constant
Switching frequency 2	1kHz to 135kHz	boost converter, load dependent
Switching frequency 3	40kHz to 210kHz	PFC converter, input voltage and load dependent

18. ENVIRONMENT

Operational temperature ¹⁾	-25°C to +70°C	reduce output power according Fig. 18-1
Storage temperature	-40°C to +85°C	for storage and transportation
Output derating	20W/°C	between +55°C and +70°C
Humidity ²⁾	5 to 95% r.H.	IEC 60068-2-30
Vibration sinusoidal	2-17.8Hz: ±1.6mm; 17.8-500Hz: 1g ³⁾ 2 hours / axis	IEC 60068-2-6
Shock	15g 6ms, 10g 11ms ³⁾ 3 bumps / direction, 18 bumps in total	IEC 60068-2-27
Altitude	0 to 2000m 2000m to 5000m	without any restrictions reduce output power or ambient temperature, see Fig. 18-2
Altitude derating	60W/1000m or 5°C/1000m	> 2000m, see Fig. 18-2
Over-voltage category	III II	IEC/UL 61010-2-201 up to 4000m IEC/UL 61010-2-201 up to 5000m
Degree of pollution	2	IEC/UL 61010-2-201 not conductive

- 1) Operational temperature is the same as the ambient or surrounding temperature and is defined as the air temperature 2cm below the unit. Curves and figures for operation on only 2 legs of a 3-phase system can be found in chapter 26.4.
- 2) Do not energize while condensation is present.
- 3) Higher levels allowed when using the wall mounting bracket ZM2.WALL

Fig. 18-1 Output current vs. ambient temp.

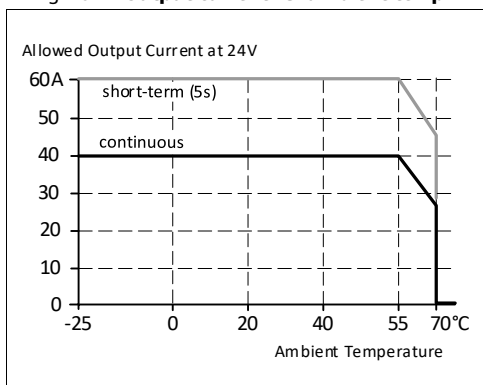
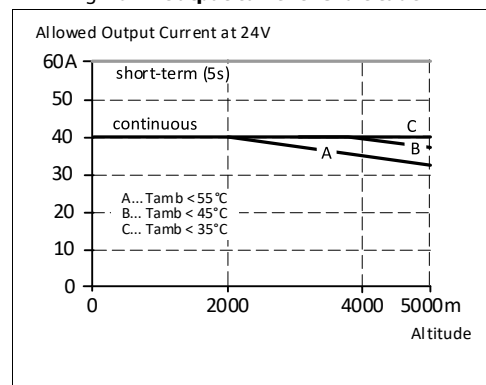

Fig. 18-2 Output current vs. altitude



19. PROTECTION FEATURES

Output protection	Electronically protected against overload, no-load and short-circuits ¹⁾	
Output overvoltage protection	typ. 30Vdc max. 32Vdc	In case of an internal power supply defect, a redundant circuit limits the maximum output voltage. The output shuts down and automatically attempts to restart.
Degree of protection	IP20	EN/IEC 60529 Caution: For use in a controlled environment according to CSA 22.2 No 107.1-01.
Penetration protection	> 5mm	e.g. screws, small parts
Overtemperature protection	yes	output shut-down with automatic restart
Input transient protection	MOV (Metal Oxide Varistor)	
Internal input fuse	included	not user replaceable

1) In case of a protection event, audible noise may occur.

20. SAFETY FEATURES

The supply voltage for the IO-Link must be powered from a PELV or SELV source or an "Isolated Secondary Circuit" in order to maintain a SELV or PELV output. Do not connect the IO-Link port to any other equipment except industrial control equipment.

Input / output separation ¹⁾	SELV	IEC/UL 61010-2-201
	PELV	IEC/UL 61010-2-201
	double or reinforced insulation	
Class of protection	I	PE (Protective Earth) connection required
Isolation resistance	> 100MΩ	input to output, 500Vdc
PE resistance	< 0.1Ω	
Touch current (leakage current)	typ. 0.35mA / 0.64mA	3x400Vac, 50Hz, TN-,TT-mains / IT-mains
	typ. 0.45mA / 0.91mA	3x480Vac, 60Hz, TN-,TT-mains / IT-mains
	max. 0.45mA / 0.78mA	3x440Vac, 50Hz, TN-,TT-mains / IT-mains
	max. 0.60mA / 1.20mA	3x528Vac, 60Hz, TN-,TT-mains / IT-mains

1) double or reinforced insulation

21. DIELECTRIC STRENGTH

The output voltage is floating and has no ohmic connection to the ground. Type and factory tests are conducted by the manufacturer. Field tests may be conducted in the field using the appropriate test equipment which applies the voltage with a slow ramp (2s up and 2s down). Connect all phase terminals together as well as all output poles before conducting the test. When testing, set the cut-off current settings to the value in the table below.

Fig. 21-1 Dielectric strength

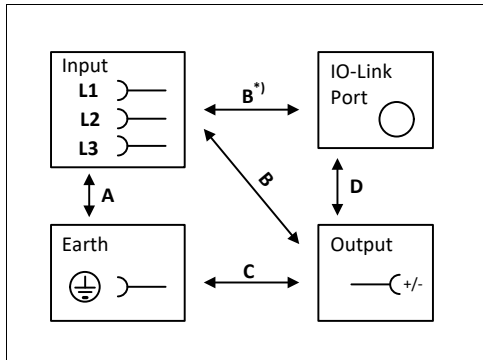

		A	B	C	D
Type test	60s	2500Vac	3000Vac	500Vac	500Vac
Factory test	5s	2500Vac	2500Vac	500Vac	500Vac
Field test	5s	2000Vac	2000Vac	500Vac	500Vac
Cut-off current setting		> 10mA	> 10mA	> 40mA	> 1mA



To fulfil the PELV requirements according to EN 60204-1 § 6.4.1, we recommend that either the + pole, the - pole or any other part of the output circuit shall be connected to the protective earth system. This helps to avoid situations in which a load starts unexpectedly or can not be switched off when unnoticed earth faults occur.

B*) When testing input to DC-OK ensure that the max. voltage between DC-OK and the output is not exceeded (column D). We recommend connecting DC-OK pins and the output pins together when performing the test.

22. APPROVED, FULFILLED OR TESTED STANDARDS

IEC 61010-2-201	CB Report	CB Scheme Certificate Electrical Equipment for Measurement, Control and Laboratory Use - Particular requirements for control equipment
UL 61010-2-201		UL Certificate Listed equipment for category NMTR - Electrical Equipment for Measurement, Control and Laboratory Use - Particular requirements for control equipment Applicable for US and Canada E-File: E198865
SEMI F47	SEMI F47	Test Report Voltage Sag Immunity for Semiconductor Processing Equipment Tested for 3AC 400V L-L mains voltages, nominal output voltage and nominal output load
VDMA 24364	LABS VDMA 24364-C1-L/W	Paint Wetting Impairment Substances Test (or LABS-Test) Tested for Zone 2 and test class C1 according to VDMA 24364-C1-L/W for solvents and water-based paints

23. REGULATORY PRODUCT COMPLIANCE

EU Declaration of Conformity		The CE mark indicates conformance with the - EMC directive - Low-voltage directive - RoHS directive
REACH Regulation (EU)		Manufacturer's Statement EU regulation regarding the Registration, Evaluation, Authorisation and Restriction of Chemicals (REACH) fulfilled.
WEEE Regulation		Manufacturer's Declaration EU Regulation on Waste Electrical and Electronic Equipment Registered as business to business (B2B) products.

24. PHYSICAL DIMENSIONS AND WEIGHT

Width	110mm
Height	124mm
Depth	143.5mm The DIN rail depth must be added to the unit depth to calculate the total required installation depth.
Weight	1500g
DIN rail	Use 35mm DIN rails according to EN 60715 or EN 50022 with a height of 7.5 or 15mm.
Housing material	Body: aluminium alloy Cover: zinc-plated steel
Installation Clearances	See chapter 2

Fig. 24-1 **Front view**

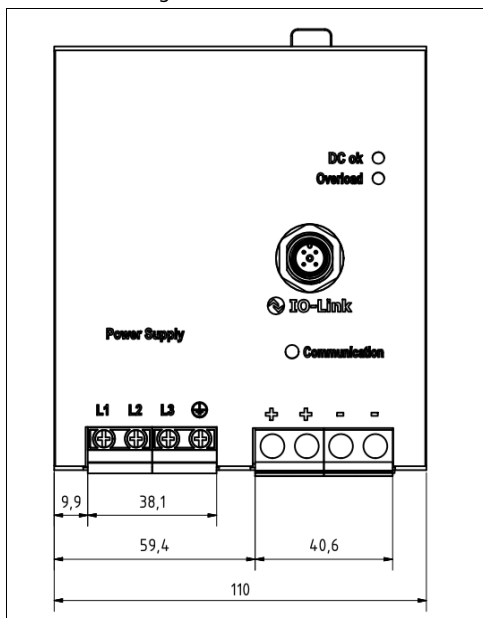
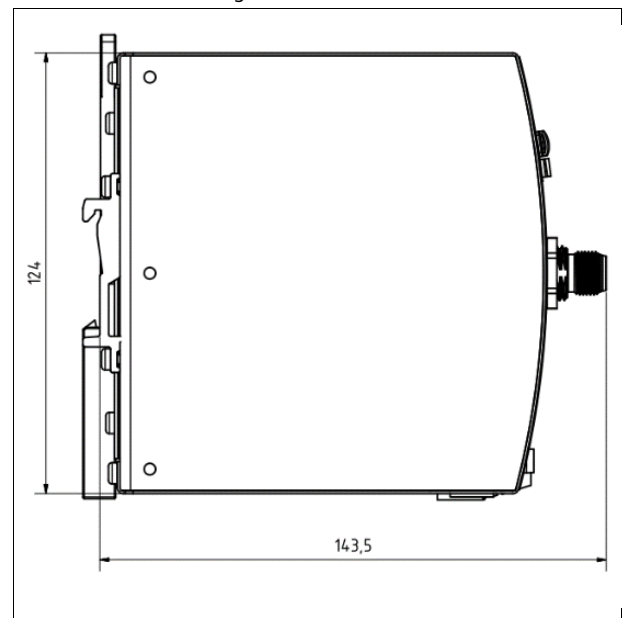

Fig. 24-2 **Side view**



25. ACCESSORIES

25.1. ZM2.WALL - WALL MOUNTING BRACKET

This bracket is used to mount specific DIMENSION units onto a flat surface without utilizing a DIN rail.

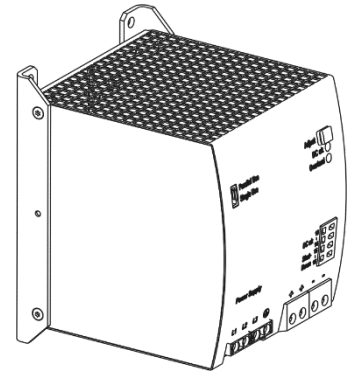
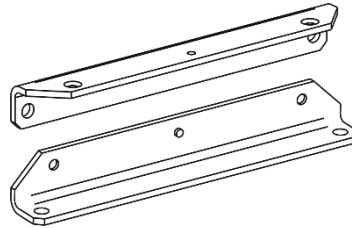

25.2. UF20.241 - BUFFER MODULE



This buffer unit is a supplementary device for DC 24V power supplies. It delivers power to bridge typical mains failures or extends the hold-up time after turn-off of the AC power. In times when the power supply provides sufficient voltages, the buffer unit stores energy in integrated electrolytic capacitors. In case of mains voltage fault, this energy is released again in a regulated process. One buffer module can deliver 20A. To buffer the full output current of 40A, two buffer modules are needed in parallel.

The buffer unit does not require any control wiring. It can be added in parallel to the load circuit at any given point. Buffer units can be added in parallel to increase the output ampacity or the hold-up time.

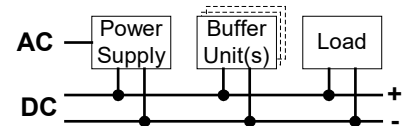

25.3. YR80.241 - REDUNDANCY MODULE

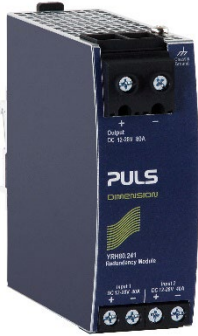

The YR80.241 is equipped with two input channels (40A each), which are individually decoupled by utilizing MOSFET technology. The output current can go as high as 80A. Using MOSFETs instead of diodes reduces the heat generation and the voltage drop between input and output. The YR80.241 does not require an additional auxiliary voltage and is self-powered even in case of a short circuit across the output. Due to the low power losses, the unit is very slender and only requires 46mm width on the DIN rail.

Fig. 25-1 **Typical 1+1 Redundant configuration for 40A with a dual redundancy module**

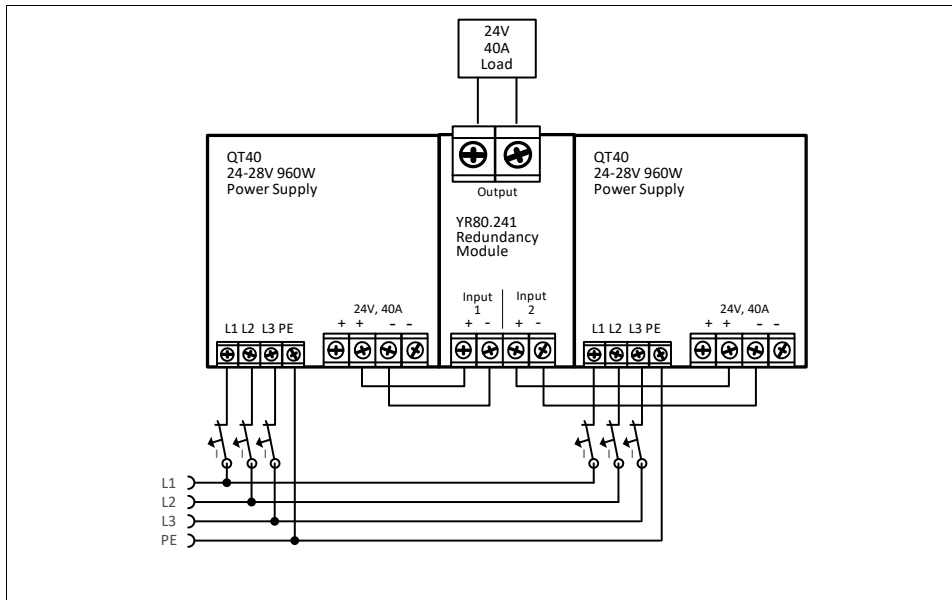

26. APPLICATION NOTES

26.1. REPETITIVE PULSE LOADING

Typically, a load current is not constant and varies over time. This power supply is designed to support loads with a higher short-term power demand (= BonusPower). The short-term duration is hardware controlled by an output power manager and is available on a repeated basis. If the BonusPower load lasts longer than the hardware controller allows it, the output voltage will dip and the next BonusPower is available after the BonusPower recovery time (see chapter 6) has elapsed.

To avoid this, the following rules must be met:

- The power demand of the pulse must be below 150% of the nominal output power.
- The duration of the pulse power must be shorter than the allowed BonusPower time. (see output section)
- The average (R.M.S.) output current must be below the specified continuous output current.
If the R.M.S. current is higher, the unit will respond with a thermal shut-down after a period of time. Use the maximum duty cycle curve (Fig. 26-2) to check if the average output current is below the nominal current.
- The duty cycle must be below 0.5.

Fig. 26-1 Repetitive pulse loads, definitions

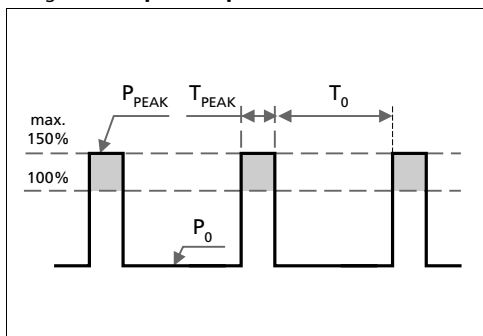

- P_0 Base load (W)
- P_{PEAK} Pulse load (above 100%)
- T_0 Duration between pulses (s)
- T_{PEAK} Pulse duration (s)

Fig. 26-2 Max. duty cycle curve

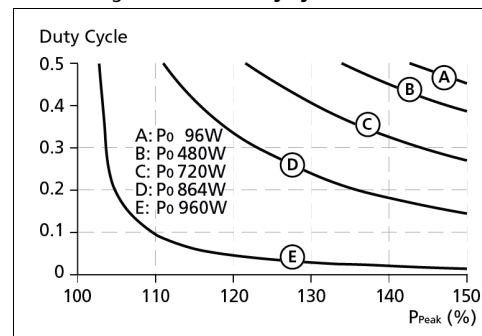

$$\text{DutyCycle} = \frac{T_{peak}}{T_{peak} + T_0}$$

$$T_0 = \frac{T_{peak} - (\text{DutyCycle} \times T_{peak})}{\text{DutyCycle}}$$

Example: A load is powered continuously with 480W (= 50% of the rated output load). From time to time a peak power of 1440W (= 150% of the rated output load) is needed for 1 second.

The question is: How often can this pulse be supplied without overloading the power supply?

- Make a vertical line at $P_{PEAK} = 150\%$ and a horizontal line where the vertical line crosses the $P_0 = 50\%$ curve. Read the max. duty cycle from the duty cycle-axis (= 0.37)
- Calculate the required pause (base load) length T_0 :
- Result: The required pause length = 1.7s
- Max. repetition rate = pulse + pause length = **2.7s**

$$T_0 = \frac{T_{peak} - (\text{DutyCycle} \times T_{peak})}{\text{DutyCycle}} = \frac{1s - (0.37 \times 1s)}{0.37} = 1.7s$$

More examples for pulse load compatibility:

P_{PEAK}	P_0	T_{PEAK}	T_0	P_{PEAK}	P_0	T_{PEAK}	T_0
1440W	960W	1s	>25s	1440W	480W	0.1s	>0.16s
1440W	0W	1s	>1.3s	1440W	480W	1s	>1.6s
1200W	480W	1s	>0.75s	1440W	480W	3s	>4.9s

26.2. PEAK CURRENT CAPABILITY

The power supply can deliver peak currents (up to several milliseconds) which are higher than the specified short term currents.

This helps to start current demanding loads. Solenoids, contactors and pneumatic modules often have a steady state coil and a pick-up coil. The inrush current demand of the pick-up coil is several times higher than the steady-state current and usually exceeds the nominal output current (including the BonusPower). The same situation applies when starting a capacitive load.

The peak current capability also ensures the safe operation of subsequent circuit breakers of load circuits. The load branches are often individually protected with circuit breakers or fuses. In case of a short or an overload in one branch circuit, the fuse or circuit breaker need a certain amount of overcurrent to open in a timely manner. This avoids voltage loss in adjacent circuits.

The extra current (peak current) is supplied by the power converter and the built-in large sized output capacitors of the power supply. The capacitors get discharged during such an event, which causes a voltage dip on the output. The following two examples show typical voltage dips:

Fig. 26-3 Peak load with 2x the nominal current for 50ms, typ.

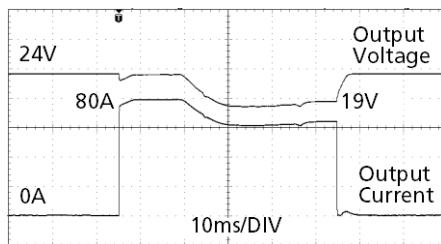

80A_{peak} load (resistive) for 50ms
Output voltage dips from 24V to 19V.

Fig. 26-4 Peak load with 5x the nominal current for 5ms, typ.

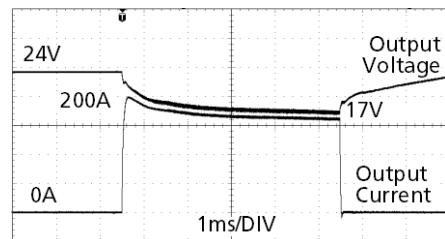

200A_{peak} load (resistive) for 5ms
Output voltage dips from 24V to 17V.

Please note: The DC-OK relay triggers when the voltage dips more than 10% for longer than 1ms.

Peak current voltage dips	typ.	from 24V to 19V	at 80A for 50ms, resistive load
	typ.	from 24V to 18V	at 200A for 2ms, resistive load
	typ.	from 24V to 17V	at 200A for 5ms, resistive load

26.3. EXTERNAL INPUT PROTECTION

The unit is tested and approved for branch circuits up to 30A (U.S.A.) and 32A (IEC). An external protection is only required if the supplying branch has an ampacity greater than this. Check also local codes and local requirements. In some countries local regulations might apply.

If an external fuse is necessary or utilized, minimum requirements need to be considered to avoid nuisance tripping of the circuit breaker. A minimum value of 6A B- or C-Characteristic breaker should be chosen.

26.4. USING ONLY 2 LEGS OF A 3-PHASE SYSTEM

No external protection devices are required to protect against a phase-loss failure.

This power supply can also be permanently operated on two legs of a 3-phase system. However, it is not recommended for this power class since the supplying 3-phase network can become unbalanced.

The output power must be reduced according to the curves below when operation on only two legs of a 3-phase system. A long-term exceeding of these limits will result in a thermal shut-down of the unit.

A use below 340Vac with more than 30A output current can also result in a thermal shut-down.

During power-on, some start-up attempts can occur until a permanent output power is available.

EMC performance, hold-up time, losses and output ripple differ from a three phase operation. Therefore, check suitability of your individual application.

Such use is not included in the UL approval. Additional tests might be necessary when the complete system has to be approved according to UL 61010-2-201.

The screw of the terminal which remains unused must be securely tightened.

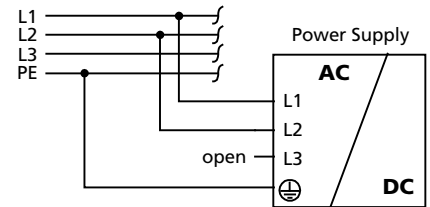

Fig. 26-5

Output current vs. ambient temperature

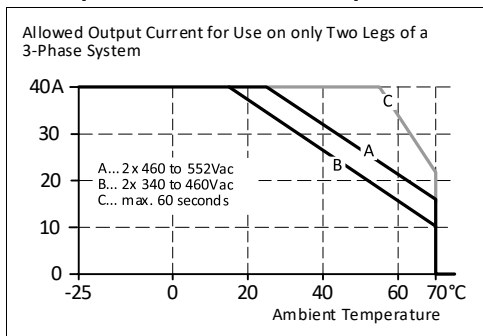

Fig. 26-6

Hold-up time vs. input voltage

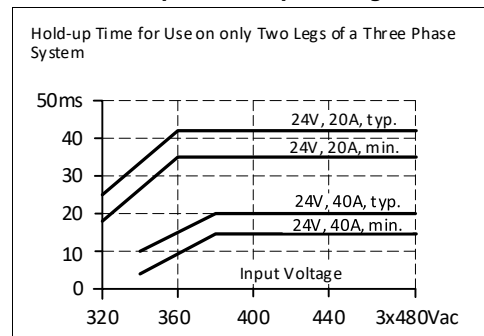

Fig. 26-7

Efficiency vs. output current at 24V

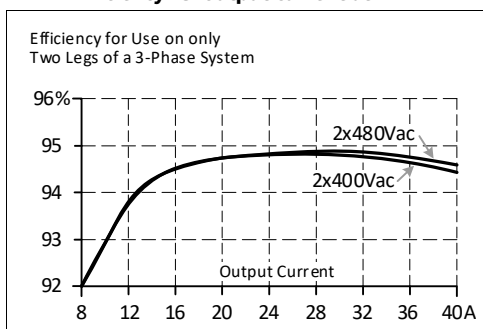
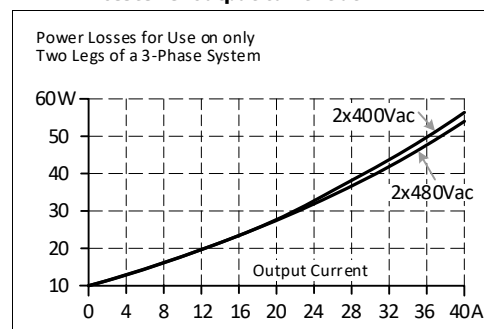

Fig. 26-8

Losses vs. output current at 24V



26.5. CHARGING OF BATTERIES

The power supply can be used to charge lead-acid or maintenance free batteries (two 12V batteries in series).

Instructions for charging batteries:

- a) Set output voltage (measured at no load and at the battery end of the cable) very precisely to the end-of-charge voltage.

End-of-charge voltage	27.8V	27.5V	27.15V	26.8V
Battery temperature	10°C	20°C	30°C	40°C

- b) Use a 50A or 63A circuit breaker (or blocking diode) between the power supply and the battery.
- c) Ensure that the output current of the power supply is below the allowed charging current of the battery.
- d) Use only matched batteries when putting 12V types in series.
- e) The return current to the power supply (battery discharge current) is typ. 18mA when the power supply is switched off (except in case a blocking diode is utilized).

26.6. OUTPUT CIRCUIT BREAKERS

Standard miniature circuit breakers (MCB's or UL1077 circuit breakers) are commonly used for AC-supply systems and may also be used on DC branches.

MCB's are designed to protect wires and circuits. If the ampere value and the characteristics of the MCB are adapted to the wire size that is used, the wiring is considered as thermally safe regardless of whether the MCB opens or not.

To avoid voltage dips and under-voltage situations in adjacent 24V branches which are supplied by the same source, a fast (magnetic) tripping of the MCB is desired. A quick shutdown within 10ms is necessary corresponding roughly to the ride-through time of PLC's. This requires power supplies with high current reserves and large output capacitors. Furthermore, the impedance of the faulty branch must be sufficiently small in order for the current to actually flow. The best current reserve in the power supply does not help if Ohm's law does not permit current flow. The following table has typical test results showing which B- and C-Characteristic MCBs magnetically trip depending on the wire cross chapter and wire length.

Fig. 26-9 Test circuit

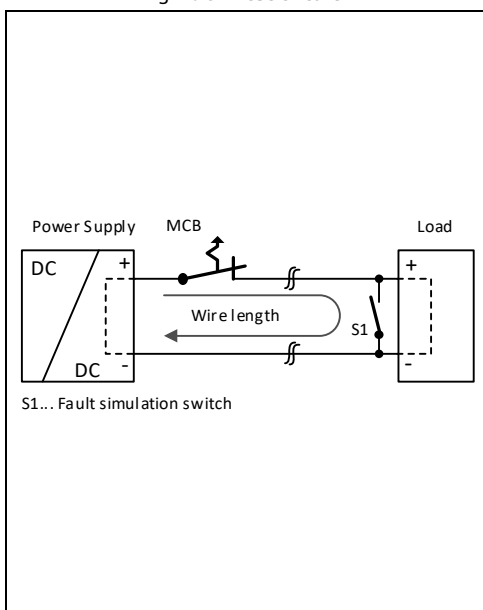

Maximal wire length¹⁾ for a fast (magnetic) tripping:

	0.75mm ²	1.0mm ²	1.5mm ²	2.5mm ²
C-2A	31 m	42 m	62 m	92 m
C-3A	28 m	36 m	51 m	77 m
C-4A	18 m	23 m	36 m	55 m
C-6A	11 m	14 m	21 m	33 m
C-8A	8 m	12 m	18 m	27 m
C-10A	7 m	10 m	15 m	22 m
C-13A	4 m	6 m	8 m	13 m
C-16A	2 m	3 m	4 m	7 m
C-20A	1 m	2 m	3 m	5 m
B-6A	23 m	29 m	40 m	64 m
B-10A	13 m	16 m	24 m	38 m
B-13A	11 m	13 m	20 m	32 m
B-16A	8 m	12 m	18 m	26 m
B-20A	4 m	6 m	9 m	15 m
B-25A	3 m	4 m	7 m	9 m
B-32A	3 m	4 m	5 m	7 m

1) Don't forget to consider twice the distance to the load (or cable length) when calculating the total wire length (+ and - wire).

26.7. PARALLEL USE TO INCREASE OUTPUT POWER

Power supplies from the same series (Q-Series) can be paralleled to increase the output power. The output voltage of all power supplies shall be adjusted to the same value (± 100 mV) in "Single Use" mode with the same load conditions on all units, or the units can be left with the factory settings. After the adjustments, set the unit to "Parallel Use" mode via IO-Link interface in order to achieve load sharing.

If more than three units are connected in parallel, a fuse or circuit breaker with a rating of 50A or 63A is required on each output. Alternatively, a diode or redundancy module can also be utilized.

Keep an installation clearance of 15mm (left / right) between two power supplies and avoid installing the power supplies on top of each other. Do not use power supplies in parallel in mounting orientations other than the standard mounting orientation (terminals on the bottom of the unit) or in any other condition where a derating of the output current is required (e.g. altitude, above +60°C, ...).

Pay attention that leakage current, EMI, inrush current, harmonics will increase when using multiple power supplies.

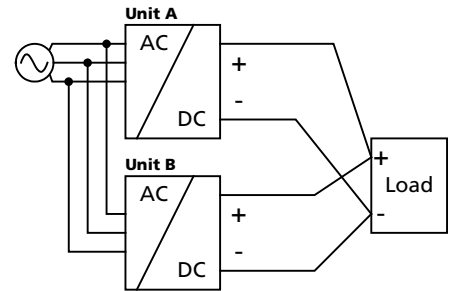

26.8. PARALLEL USE FOR REDUNDANCY

Power supplies can be paralleled for redundancy to gain higher system availability. Redundant systems require a certain amount of extra power to support the load in case one power supply unit fails. The simplest way is to put two power supplies in parallel. This is called a 1+1 redundancy. In case one power supply unit fails, the other one is automatically able to support the load current without any interruption. Redundant systems for a higher power demand are usually built in a N+1 method. E.g. five power supplies, each rated for 40A are paralleled to build a 160A redundant system. For N+1 redundancy the same restrictions apply as for increasing the output power, see also chapter 26.7.

Please note: This simple way to build a redundant system does not cover failures such as an internal short circuit in the secondary side of the power supply. In such a case, the defective unit becomes a load for the other power supplies and the output voltage cannot be maintained any more. This can be avoided by utilizing redundancy modules, which have decoupling devices (diodes or MOSFETs) included. Further information and wiring configurations can be found in chapter 25.3.

Recommendations for building redundant power systems:

- Use separate input fuses for each power supply. A separate source for each supply when possible increases the reliability of the redundant system.
- Set the devices into "Parallel Use" mode via IO-Link interface, see chapter 8.
- Monitor the individual power supply units. Therefore, use the IO-Link event of the QT40 power supply.
- It is desirable to set the output voltages of all units to the same value or leave it at the factory setting.

26.9. SERIES OPERATION

Power supplies of the same type can be connected in series for higher output voltages. It is possible to connect as many units in series as needed, providing the sum of the output voltage does not exceed 150Vdc. Voltages with a potential above 60Vdc are not SELV anymore and can be dangerous. Such voltages must be installed with a protection against touching.

Earthing of the output is required when the sum of the output voltage is above 60Vdc.

Avoid return voltage (e.g. from a decelerating motor or battery) which is applied to the output terminals.

Keep an installation clearance of 15mm (left / right) between two power supplies and avoid installing the power supplies on top of each other. Do not use power supplies in series in mounting orientations other than the standard mounting orientation (terminals on the bottom of the unit).

Pay attention that leakage current, EMI, inrush current, harmonics will increase when using multiple power supplies.

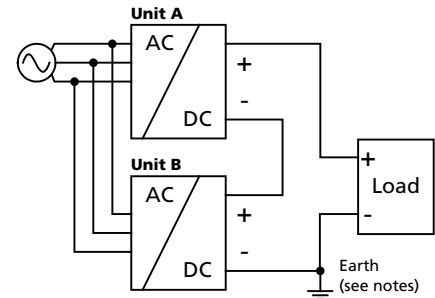

26.10. INDUCTIVE AND CAPACITIVE LOADS

The unit is designed to supply any kind of loads, including capacitive and inductive loads.

26.11. BACK-FEEDING LOADS

Loads such as decelerating motors and inductors can feed voltage back to the power supply. This feature is also called return voltage immunity or resistance against Back- E.M.F. (Electro Magnetic Force).

This power supply is resistant and does not show malfunctioning when a load feeds back voltage to the power supply. It does not matter whether the power supply is on or off.

The maximum allowed feed-back-voltage is 35Vdc. The absorbing energy can be calculated according to the built-in large sized output capacitor which is specified in chapter 6. Feed-back-voltages can be detected and accessed via the IO-Link interface, as described in chapter 8.

26.12. USE IN A TIGHTLY SEALED ENCLOSURE

When the power supply is installed in a tightly sealed enclosure, the temperature inside the enclosure will be higher than outside. In such situations, the inside temperature defines the ambient temperature for the power supply.

The following measurement results can be used as a reference to estimate the temperature rise inside the enclosure.

The power supply is placed in the middle of the box, no other heat producing items are inside the box

Enclosure:	Rittal Typ IP66 Box PK 9522 100, plastic, 254x180x165mm
Load:	24V, 32A; (=80%) load is placed outside the box
Input:	3x 400Vac
Temperature inside enclosure:	+57.5°C (in the middle of the right side of the power supply with a distance of 2cm)
Temperature outside enclosure:	+23.6°C
Temperature rise:	33.9K

26.13. MOUNTING ORIENTATIONS

Mounting orientations other than all terminals on the bottom require a reduction in continuous output power or a limitation in the maximum allowed ambient temperature. The amount of reduction influences the lifetime expectancy of the power supply. Therefore, two different derating curves for continuous operation can be found below:

Curve A1

Recommended output current.

Curve A2

Max. allowed output current (results in approximately half the lifetime expectancy of A1).

Fig. 26-10
Mounting Orientation A
(Standard orientation)

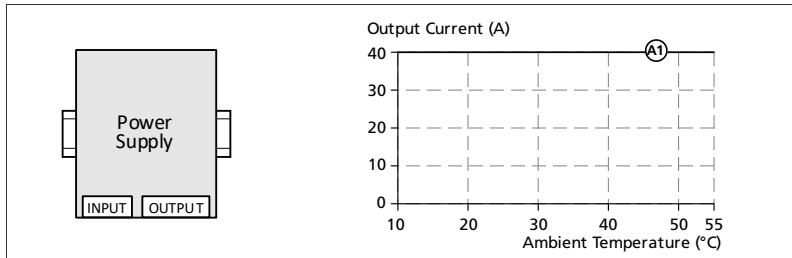

Fig. 26-11
Mounting Orientation B
(Upside down)

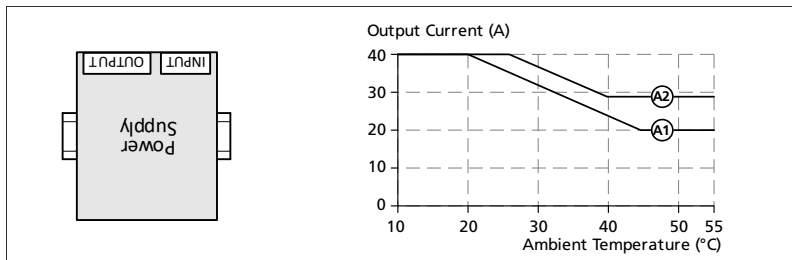

Fig. 26-12
Mounting Orientation C
(Table-top mounting)

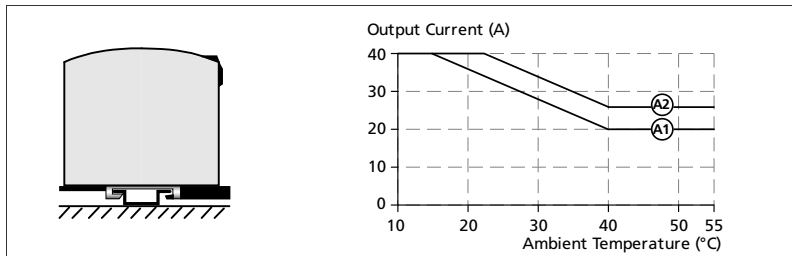

Fig. 26-13
Mounting Orientation D
(Horizontal cw)

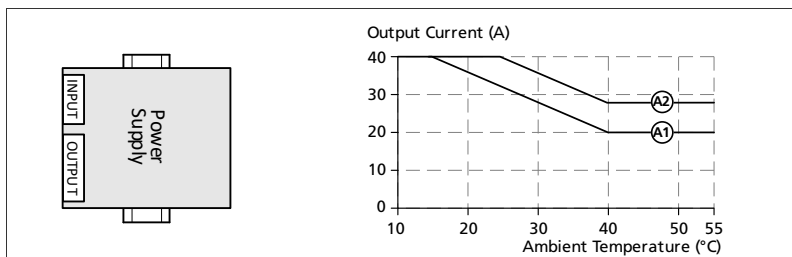

Fig. 26-14
Mounting Orientation E
(Horizontal ccw)

