



POWER SUPPLY 100-240 Vac, 24 V, 960 W

- AC 100-240 V wide-range input
- Compact width: Only 96 mm
- Efficiency 96.4 % at 24 V, 40 A
- Power losses at no load: 2.6 W
- Dynamic BonusPower management:
Max. 1440 W for up to 5 s and 1152 W continuous (up to +45 °C)
- Enhanced Hiccup^{PLUS} protects connected systems and power supply from overload
- DC-OK relay contact
- 3 year warranty

PRODUCT DESCRIPTION

PLANET power supplies are the top of the line industrial grade DIN rail power supplies from PULS. Compact size, high efficiency and dynamic BonusPower capabilities make the **PLANET** power supplies stand out.

Thanks to the integrated **dynamic BonusPower management**, the power supply can adapt to varying power demands in real-time. By continuously monitoring the power output through a power-time-integral, it can provide extra power for different durations. For example, the power supply can deliver 110 % of its rated power for 30 s or up to 150 % for 5 s at temperatures up to +60 °C. At temperatures up to +45 °C, it can continuously provide 120 % of its rated power. This flexible power management ensures that the power supply meets peak demands without being constrained to fixed power values, enhancing overall performance and reliability.

The high efficiency from stand-by to full load reduces total cost of ownership and carbon dioxide emissions, with particularly low power losses during no-load conditions.

Robust against back-feeding events, **PLANET** power supplies minimise downtime and ensure safety and reliability with Hiccup^{PLUS} mode in case of overload.

The **PLANET SP** series combines these features in highly reliable and elegantly designed DIN rail power supplies. The **SP960.241-S** model is equipped with classic screw terminals for a secure connection.

SHORT-FORM DATA

Output voltage	DC 24 V	nominal
Adjustment range	24 - 28 Vdc	
Output current	AC 120 - 240 V mains	
	48 - 41.1 A	up to +45 °C
	40 - 34.3 A	up to +60 °C
	30 - 25.7 A	at +70 °C
Short term (5 s) Derating	60 - 51.5 A	up to +70 °C
	linearly 24 W/K	+60 °C to +70 °C
	AC 100 V mains	
	48 - 41.1 A	up to +40 °C
	40 - 34.3 A	up to +55 °C
	38 - 32.6 A	up to +60 °C
	30 - 25.7 A	at +70 °C
Short term (5 s) Derating	60 - 51.5 A	up to +70 °C
	linearly 9.6 W/K	+55 °C to +60 °C
	linearly 19.2 W/K	+60 °C to +70 °C
Input voltage AC	AC 100 - 240 V	±10 %
Input current AC	8.5 / 4.4 A	at 120 / 230 Vac
Power factor	0.998 / 0.993	at 120 / 230 Vac
Inrush current AC	14 / 8 A _{peak}	at 120 / 230 Vac
Efficiency	95.1 / 96.4 %	at 120 / 230 Vac
Power losses	49.5 / 35.9 W	at 120 / 230 Vac
Hold-up time	28 / 28 ms	at 120 / 230 Vac
Temperature range	-25 °C to +70 °C	
Size (w x h x d)	96x124x132 mm	without DIN rail
Weight	1700 g	

ORDER NUMBERS

Power Supply SP960.241-S

Complementary units:

- ZM2.WALL Wall / Panel mount bracket
- UF40.241 Buffer module 24 V, 40 A
- UB40.241 DC-UPS control unit 24 V, 40 A

MAIN APPROVALS

For details and the complete approval list, see chapter 21.

Index

1	Intended Use.....	3	13	Functional Diagram.....	13
2	Installation Instructions.....	3	14	Terminals and Wiring.....	14
3	AC Input.....	4	15	Front Side and User Elements.....	15
4	DC Input.....	5	16	EMC.....	16
5	Input Inrush Current.....	5	17	Environment.....	17
6	Output.....	6	18	Protection Features.....	18
7	Dynamic BonusPower Management.....	8	19	Safety Features.....	18
8	Hold-up Time.....	9	20	Dielectric Strength.....	19
9	DC-OK Relay Contact.....	10	21	Approved, Fulfilled or Tested Standards.....	20
10	Efficiency and Power Losses.....	11	22	Regulatory Product Compliance.....	20
11	Lifetime Expectancy.....	12	23	Physical Dimensions and Weight.....	21
12	MTBF.....	12			

The information given in this document is correct to the best of our knowledge and experience at the time of publication. If not expressly agreed otherwise, this information does not represent a warranty in the legal sense of the word. As the state of our knowledge and experience is constantly changing, the information in this data sheet is subject to revision. We therefore kindly ask you to always use the latest issue of this document (available under www.pulspower.com).

No part of this document may be reproduced or utilised in any form without our prior permission in writing.

Packaging and packaging aids can and should always be recycled. The product itself may not be disposed of as domestic refuse.

Terminology and Abbreviation

PE and \oplus Symbol	PE is the abbreviation for Protective Earth and has the same meaning as the symbol \oplus .
Earth, Ground	This document uses the term "earth" which is the same as the U.S. term "ground".
t.b.d.	To be defined, value or description will follow later.
AC 230 V	A figure displayed with the AC or DC before the value represents a nominal voltage with standard tolerances (usually $\pm 15\%$) included. E.g.: DC 12 V describes a 12 V battery disregarding whether it is full (13.7 V) or flat (10 V)
230 Vac	A figure with the unit (Vac) at the end is a momentary figure without any additional tolerances included.
50 Hz vs. 60 Hz	As long as not otherwise stated, AC 100 V and AC 230 V parameters are valid at 50 Hz mains frequency. AC 230 V parameters are valid for 60 Hz mains frequency.
may	A key word indicating flexibility of choice with no implied preference.
shall	A key word indicating a mandatory requirement.
should	A key word indicating flexibility of choice with a strongly preferred implementation.

1. Intended Use

This device is designed for installation in an enclosure and is intended for commercial use, such as in industrial control, process control, monitoring and measurement equipment or the like.

Do not use this device in equipment where malfunction may cause severe personal injury or threaten human life.

If this device is used in a manner outside of its specification, the protection provided by the device may be impaired.

2. Installation Instructions

⚠ DANGER Risk of electrical shock, fire, personal injury or death.

- Turn power off before working on the device. Protect against inadvertent re-powering.
- Do not open, modify or repair the device.
- Use caution to prevent any foreign objects from entering the housing.
- Do not use in wet locations or in areas where moisture or condensation can be expected.
- Do not touch during power-on, and immediately after power-off. Hot surfaces may cause burns.

Obey the following installation instructions:

This device may only be installed and put into operation by qualified personnel. This device does not contain serviceable parts. The tripping of an internal fuse is caused by an internal defect. If damage or malfunction should occur during installation or operation, immediately turn power off and send unit to the factory for inspection.

Install device in an enclosure providing protection against electrical, mechanical and fire hazards. Install the device onto a DIN rail according to EN 60715 with the input terminals on the bottom of the device. Other mounting orientations require a reduction in output current.

Make sure that the wiring is correct by following all local and national codes. Use appropriate copper cables that are designed for a minimum operating temperature of +60 °C for ambient temperatures up to +45 °C, +75 °C for ambient temperatures up to +60 °C and +90 °C for ambient temperatures up to +70 °C. Ensure that all strands of a stranded wire enter the terminal connection.

Unused screw terminals should be securely tightened.

The device is designed for pollution degree 2 areas in controlled environments. No condensation or frost is allowed. The enclosure of the device provides a degree of protection of IP20.

The isolation of the device is designed to withstand impulse voltages of overvoltage category III according to IEC 60664-1.

The device is designed as "Class of Protection I" equipment according to IEC 61140. Do not use without a proper PE (Protective Earth) connection. The device is suitable to be supplied from TN-, TT- and IT- mains networks. The voltage between the L or N terminal and the PE terminal must not exceed 300 Vac continuously.

A disconnecting means shall be provided for the input of the device.

The device is designed for convection cooling and does not require an external fan. Do not obstruct airflow and do not cover ventilation grid!

The device is designed for altitudes up to 5000 m. See additional requirements in the product datasheet for use above 2000 m.

Keep the following minimum installation clearances: 40 mm on top and bottom, 5 mm left and right side. Increase the 5 mm to 15 mm in case the adjacent device is a heat source. When the device is permanently loaded with less than 50 %, the 5 mm can be reduced to zero.

The device is designed, tested and approved for branch circuits up to 32 A (IEC) and 30 A (UL) without additional protection device. If an external fuse is utilized, do not use circuit breakers smaller than 16 A B- or C-Characteristic to avoid a nuisance tripping of the circuit breaker.

The maximum surrounding air temperature is +70 °C. The operational temperature is the same as the ambient or surrounding air temperature and is defined 3 cm below the device.

The device is designed to operate in areas between 5 % and 95 % relative humidity.

3. AC Input

The device is suitable to be supplied from TN-, TT- or IT-mains networks with AC voltage.

AC input	nom.	AC 100-240 Vac	
AC input range		90-264 Vac	
Input to PE	max.	300 Vac	according to IEC 62103
Input frequency	nom.	50-60 Hz	± 6 %
Turn-on voltage	typ.	83 Vac	steady-state value, see Fig. 3-1
Shut-down voltage	typ.	73 Vac	steady-state value at 40 A load, see Fig. 3-1
External input protection	see recommendations in chapter 2		

		AC 100 V	AC 120 V	AC 230 V	
Input current	typ.	10.2 A	8.5 A	4.4 A	at 24 V, 40 A, see Fig. 3-3
Power factor ¹⁾	typ.	0.999	0.998	0.993	at 24V , 40 A, see Fig. 3-4
Start-up delay	typ.	716 ms	695 ms	763 ms	see Fig. 3-2
Rise time	typ.	92 ms	92 ms	92 ms	at 24 V, 40 A const. current load, 0 mF load capacitance, see Fig. 3-2
	typ.	93 ms	93 ms	93 ms	at 24 V, 40 A const. current load, 40 mF load capacitance, see Fig. 3-2
Turn-on overshoot	max.	100 mV	100 mV	100 mV	see Fig. 3-2

1) The power factor is the ratio of the true (or real) power to the apparent power in an AC circuit.

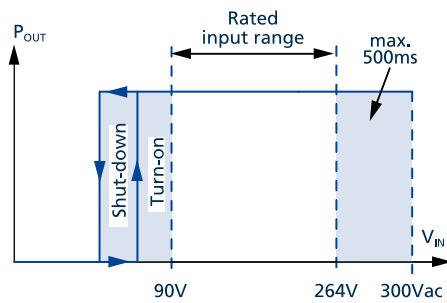

Fig. 3-1: Input voltage range

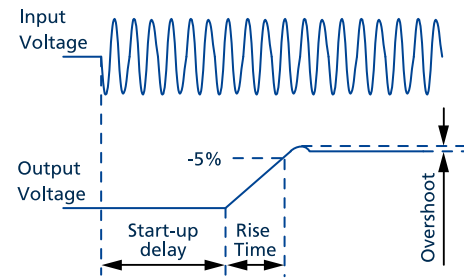

Fig. 3-2: Turn-on behavior, definitions

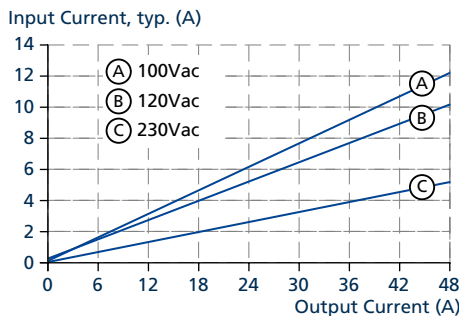

Fig. 3-3: Input current vs. output current at 24 V output voltage

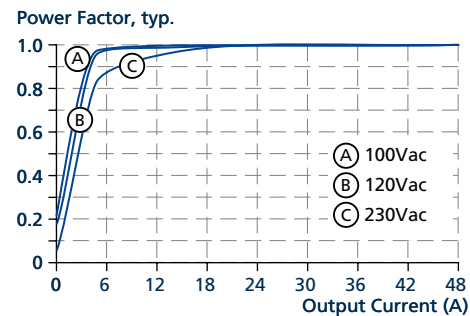

Fig. 3-4: Power factor vs. output current at 24 V output voltage

4. DC Input

Do not operate this power supply with DC input voltage.

5. Input Inrush Current

		AC 100 V	AC 120 V	AC 230 V	
Inrush current I_{peak}	max.	27 A _{peak}	22 A _{peak}	12 A _{peak}	temperature independent
	typ.	17 A _{peak}	14 A _{peak}	8 A _{peak}	temperature independent
Inrush energy I^2t	max.	28 A ² s	16 A ² s	5 A ² s	temperature independent

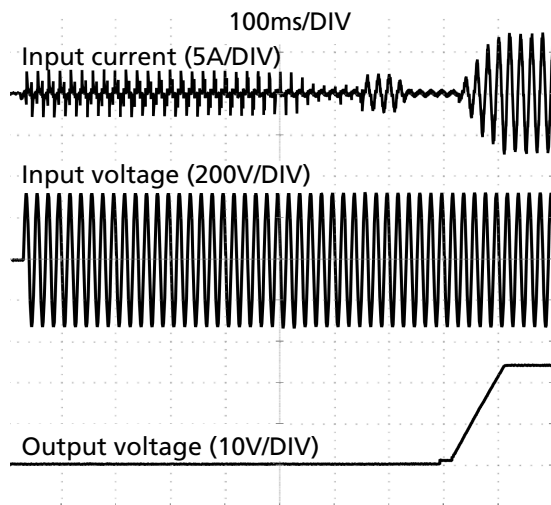

Fig. 5-1: Typical turn-on behaviour at nominal load and +25 °C ambient

6. Output

Output voltage	nom.	24 Vdc	
Adjustment range		24-28 V	stepless adjustment settings
	max.	29.5 V	This is the maximum output voltage which can occur at the clockwise end position of the potentiometer due to tolerances. It is not a guaranteed value which can be achieved.
Factory settings	typ.	24.1 V	at full load, cold unit
	typ.	25.1 V	at no load, cold unit, in "parallel use" mode
Line regulation	max.	10 mV	between 90 Vac and 264 Vac
Load regulation	max.	100 mV	in "single use" mode: static value, 0 A→40 A, see Fig. 6-2
	typ.	1000 mV	in "parallel use" mode: static value, 0 A→40 A, see Fig. 6-2
Ripple and noise voltage	max.	100 mVpp	at 20 Hz to 20 MHz, 50 Ohm
Output current	AC 120 - 240 V mains		
	nom.	40 A	at 24 V and up to +60 °C ambient temperature
	nom.	30 A	at 24 V and +70 °C ambient temperature
	nom.	34.3 A	at 28 V and up to +60 °C ambient temperature
	nom.	25.7 A	at 28 V and +70 °C ambient temperature
	Derate linearly between +60 °C and +70 °C, see Fig. 17-1		
	AC 100 V mains		
	nom.	40 A	at 24 V and up to + 55°C ambient temperature
	nom.	38 A	at 24 V and +60 °C ambient temperature
	nom.	30 A	at 24 V and +70 °C ambient temperature
	nom.	34.3 A	at 28 V and up to +55 °C ambient temperature
	nom.	32.6 A	at 28 V and +60 °C ambient temperature
	nom.	25.7 A	at 28 V and +70 °C ambient temperature
	Derate linearly between +55 °C to +60 °C and +60 °C to +70 °C, see Fig. 17-1: Output current vs. ambient temp.		
BonusPower continuous ¹⁾	nom.	48 A	at 24 V and up to +45 °C ambient temperature
	nom.	41.1 A	at 28 V and up to +45 °C ambient temperature
BonusPower continuous decreases linearly to nominal power between +45 °C and +60 °C, see Fig. 17-1			
Output power	nom.	960 W	continuously available
BonusPower continuous ¹⁾		1152 W	at 24 V, 48 A, up to +45 °C, continuous
BonusPower short term ²⁾		1440 W	at 24 V, 60 A, up to +60 °C, short term 5 s
Fuse breaking current	typ.	80 A	
Overload behaviour	Continuous current		for output voltage above 13 Vdc
	Hiccup ^{PLUS} mode ³⁾		for output voltage below 13 Vdc
Overload / short-circuit current		60.5 A	Discharge current of output capacitors is not included.
Output capacitance	nom.	9 400 µF	included inside the power supply
Back-feeding loads	max.	35 V / 2 J	The unit is resistant and does not show malfunctioning when a load feeds back voltage to the power supply. It does not matter whether the power supply is on or off. The absorbing energy can be calculated according to the built-in large sized output capacitor.

¹⁾ **BonusPower continuous:**
This power / current is continuously allowed up to an ambient temperature of +45 °C. Above +45 °C, do not use this power or current longer than a duty cycle of 10 % and / or not longer than 1 minute every 10 minutes.

²⁾ **BonusPower short term:**
The power supply is designed to support loads with a higher short-term power requirement without damage or shutdown. The short-term duration is hardware controlled by an output power manager. This power is repeatedly available.

3) **Hiccup^{PLUS} mode:**

At heavy overloads (when output voltage falls below 13 V), the power supply delivers continuous output current for 2 s. After this, the output is switched off for approx. 18 s before a new start attempt is automatically performed. This cycle is repeated as long as the overload exists. If the overload has been cleared, the device will operate normally, see Fig. 6-3.

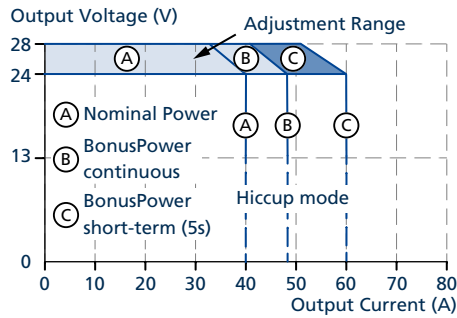

Fig. 6-1: Output voltage vs. output current, typ.

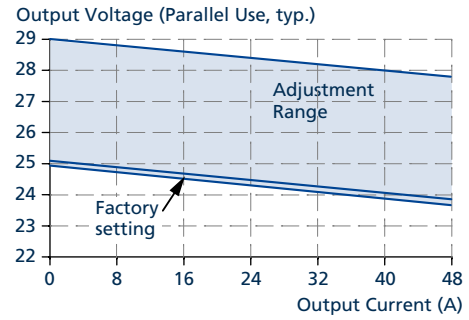

Fig. 6-2: Output voltage vs. output current in "parallel use" mode, typ.

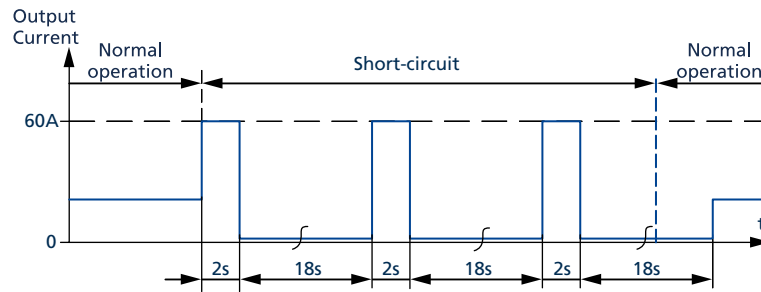

Fig. 6-3: Short-circuit on output, Hiccup^{PLUS} mode, typ.

7. Dynamic BonusPower Management

The power supply continuously monitors the power output through a power-time-integral. Therefore, BonusPower may be available longer than the maximum specified time if less BonusPower is utilised than the maximum allowed.

BonusPower utilised	Time BonusPower is available (s) at ≤ +45 °C	Time BonusPower is available (s) at ≤ +60 °C
110 %	continuous	30
120 %	continuous	14
130 %	16	9
140 %	8	7
150 %	5	5

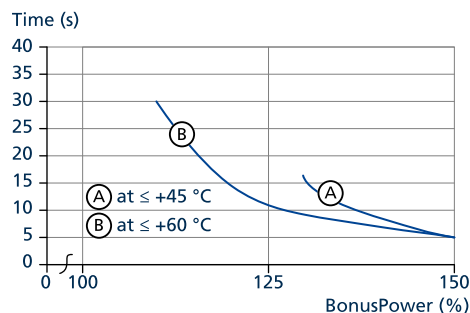

Fig. 7-1: Calculated time availability of BonusPower up to +60 °C

After operating at BonusPower, the power supply needs a cool-down period or recovery time. This can be calculated depending on the base load (<100 %) following the BonusPower period.

$$t_{\text{recover}} = \frac{P_{\text{BonusPower used}}^2 - P_{\text{nominal power}}^2}{P_{\text{nominal power}}^2 - P_{\text{base load}}^2} \times t_{\text{BonusPower used}}$$

Example:

Examples of recovery time after maximum BonusPower of 150 % was utilised for up to 5 seconds are displayed in the following table:

Base load	BonusPower time (s) at ≤ +45 °C					BonusPower time (s) at ≤ +60 °C					Recovery time (s)
	1	2	3	4	5	1	2	3	4	5	
0 %	1	1	2	2	3	1	3	4	5	6	
10 %	1	1	2	2	3	1	3	4	5	6	
20 %	1	1	2	2	3	1	3	4	5	7	
30 %	1	1	2	2	3	1	3	4	5	7	
40 %	1	1	2	3	3	1	3	4	6	7	
50 %	1	1	2	3	3	2	3	5	7	8	
60 %	1	2	2	3	4	2	4	6	8	10	
70 %	1	2	3	3	4	2	5	7	10	12	
80 %	1	2	3	4	5	3	7	10	14	17	
90 %	1	3	4	5	6	7	13	20	26	33	

8. Hold-up Time

The hold-up time is the time during which a power supply's output voltage remains within specification following the loss of input power. The hold-up time is output load dependent. At no load, the hold-up time can be up to several seconds. The green DC-OK LED is also on during the hold-up time.

The green DC-OK LED is also on during the hold-up time.

		AC 100 V	AC 120 V	AC 230 V	
Hold-up time	typ.	56 ms	56 ms	56 ms	at 24 V, 20 A, see Fig. 8-1
	min.	44 ms	44 ms	44 ms	at 24 V, 20 A, see Fig. 8-1
	typ.	28 ms	28 ms	28 ms	at 24 V, 40 A, see Fig. 8-1
	min.	22 ms	22 ms	22 ms	at 24 V, 40 A, see Fig. 8-1

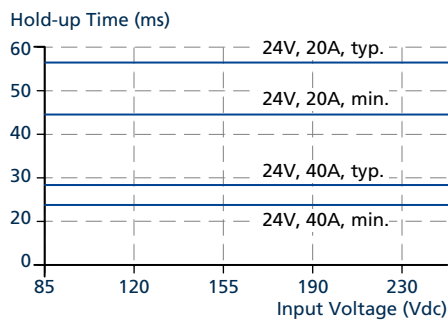

Fig. 8-1: Hold-up time vs. input voltage

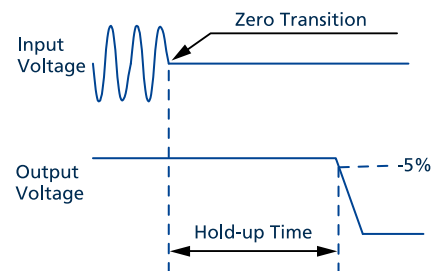

Fig. 8-2: Shut-down behaviour

9. DC-OK Relay Contact

This feature monitors the output voltage, which is produced by the power supply itself. It is independent of a back-fed voltage from a unit connected in parallel to the power supply output.

Contact closes	As soon as the output voltage reaches typ. 90 % of the adjusted output voltage level.
Contact opens	As soon as the output voltage dips more than 10 % below the adjusted output voltage. Short dips will be extended to a signal length of 100 ms. Dips shorter than 1 ms will be ignored.
Switching hysteresis	typ. 0.25 V
Contact ratings	maximum 60 Vdc 0.3 A, 30 Vdc 1 A, 30 Vac 0.5 A, resistive load minimum permissible load: 1 mA at 5 Vdc
Isolation voltage	see chapter chapter 20, dielectric strength table

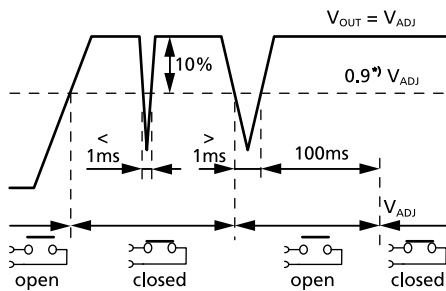

Fig. 9-1: DC-OK relay contact behaviour

10. Efficiency and Power Losses

		AC 100 V	AC 120 V	AC 230 V	
Efficiency	typ.	94.9 %	95.3 %	96.2 %	at 24 V, 20 A
	typ.	94.4 %	95.1 %	96.4 %	at 24 V, 40 A
	typ.	94.2 %	94.8 %	96.3 %	at 24 V, 48 A (BonusPower continuous)
Average efficiency ¹⁾	typ.	94.4 %	95 %	95.9 %	25 % at 10 A, 25 % at 20 A, 25 % at 30 A, 25 % at 40 A
Power losses	typ.	2.7 W	2.6 W	2.5 W	at 24 V, 0 A
	typ.	25.8 W	23.7 W	19 W	at 24 V, 20 A
	typ.	56.9 W	49.5 W	35.9 W	at 24 V, 40 A
	typ.	70.9 W	63.2 W	44.3 W	at 24 V, 48 A (BonusPower continuous)

¹⁾ The average efficiency is an assumption for a typical application where the power supply is loaded with 25 % of the nominal load for 25 % of the time, 50 % of the nominal load for another 25 % of the time, 75 % of the nominal load for another 25 % of the time and with 100 % of the nominal load for the rest of the time.

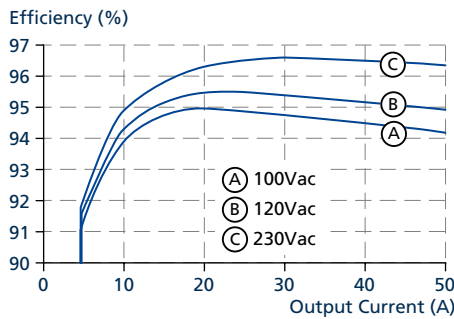

Fig. 10-1: Efficiency vs. output current at 24 V, typ.

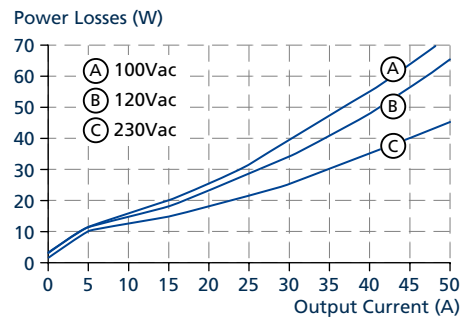

Fig. 10-2: Losses vs. output current at 24 V, typ.

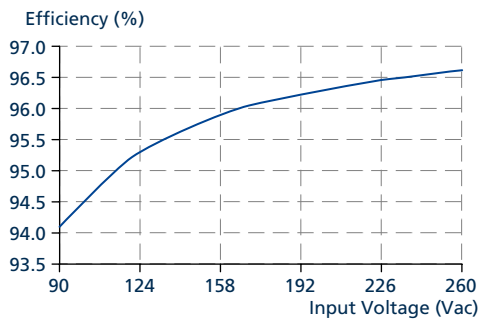

Fig. 10-3: Efficiency vs. input voltage at 24 V, 40 A, typ.

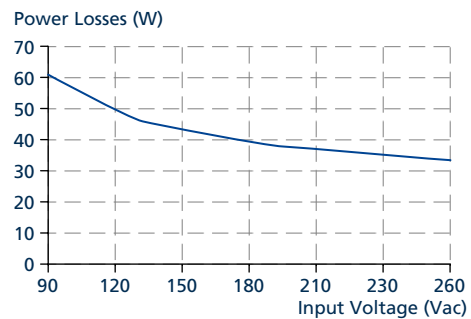

Fig. 10-4: Losses vs. input voltage at 24 V, 40 A, typ.

11. Lifetime Expectancy

The lifetime expectancy shown in the table indicates the minimum operating hours (service life) and is determined by the lifetime expectancy of the built-in electrolytic capacitors. Lifetime expectancy is specified in operational hours and is calculated according to the capacitor's manufacturer specification. The manufacturer of the electrolytic capacitors only guarantees a maximum life of up to 15 years (131 400 h). Any number exceeding this value is a calculated theoretical lifetime, which can be used to compare devices.

	AC 100 V	AC 120 V	AC 230 V	
Lifetime expectancy	281 000 h	302 000 h	345 000 h	at 24 V, 20 A and +40 °C
	796 000 h	854 000 h	975 000 h	at 24 V, 20 A and +25 °C
	79 000 h	95 000 h	134 000 h	at 24 V, 40 A and +40 °C
	224 000 h	270 000 h	380 000 h	at 24 V, 40 A and +25 °C
	37 000 h	47 000 h	74 000 h	at 24 V, 48 A and +40 °C
	106 000 h	134 000 h	208 000 h	at 24 V, 48 A and +25 °C

12. MTBF

MTBF stands for **Mean Time Between Failures**, which is calculated according to statistical device failures, and indicates reliability of a device. It is the statistical representation of the likelihood of a unit to fail and does not necessarily represent the lifetime of a product.

The MTBF figure is a statistical representation of the likelihood of a device to fail. An MTBF figure of e.g. 1 000 000 h means that statistically one unit out of 10 000 installed units will fail every 100 h. However, it can not be determined if the failed unit has been running for 50 000 h or only for 100 h.

For these types of units the MTTF (**Mean Time To Failures**) value is the same value as the MTBF value.

	AC 100 V	AC 120 V	AC 230 V	
MTBF SN 29500, IEC 61709	t.b.d. h	t.b.d. h	t.b.d. h	at 24 V, 40 A and +40 °C
	t.b.d. h	t.b.d. h	t.b.d. h	at 24 V, 40 A and +25 °C
MTBF MIL HDBK 217F	t.b.d. h	t.b.d. h	t.b.d. h	at 24 V, 40 A and +40 °C; Ground Benign GB40
	t.b.d. h	t.b.d. h	t.b.d. h	at 24 V, 40 A and +25 °C; Ground Benign GB25
	t.b.d. h	t.b.d. h	t.b.d. h	at 24 V, 40 A and +40 °C; Ground Fixed GF40
	t.b.d. h	t.b.d. h	t.b.d. h	at 24 V, 40 A and +25 °C; Ground Fixed GF25

13. Functional Diagram

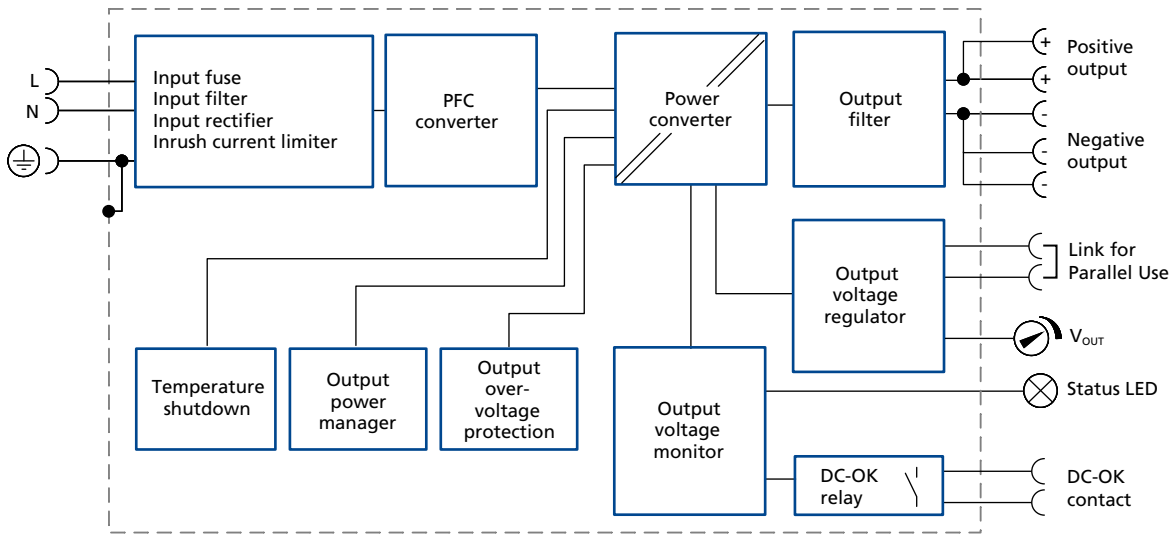

Fig. 13-1: Functional Diagram SP960.241-S

14. Terminals and Wiring

The terminals are IP20 finger safe constructed and suitable for field- and factory wiring.

	Input terminals	Output terminals	Signal terminals
Type	Screw terminals	Screw terminals	Push-in terminals
Solid wire	max. 6 mm ²	max. 16 mm ²	max. 1.5 mm ²
Stranded wire	max. 4 mm ²	max. 16 mm ²	max. 1.5 mm ²
American wire gauge	AWG 20-10	AWG 22-8	AWG 26-14
Max. wire diameter (including ferrules)	2.8 mm	5.2 mm	1.5 mm
Wire stripping length	7 mm	12 mm	8 mm
Screwdriver	3.5 mm slotted or crosshead No 2	3.5 mm slotted or crosshead No 2	3.5 mm slotted or crosshead No 2
Recommended tightening torque	1 Nm	2.3 Nm	not applicable

Instructions for wirings:

- Use appropriate copper cables that are designed for minimum operating temperatures of:
 - +60 °C for ambient up to +45 °C and
 - +75 °C for ambient up to +60 °C minimum
 - +90 °C for ambient up to +70 °C minimum.
- Follow national installation codes and installation regulations!
- Ensure that all strands of a stranded wire enter the terminal connection!
- Do not use the unit without PE connection.
- Unused terminal compartments should be securely tightened.
- Ferrules are allowed.

Daisy chaining:

Daisy chaining (jumping from one power supply output to the next) is allowed as long as the average output current through one terminal pin does not exceed 54 A. If the current is higher, use a separate distribution terminal block as shown in Fig. 14-2.

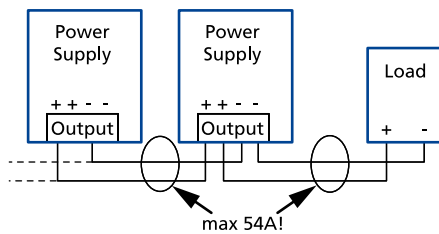

Fig. 14-1: Daisy chaining of outputs

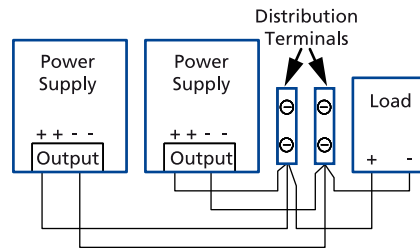

Fig. 14-2: Using distribution terminals

15. Front Side and User Elements

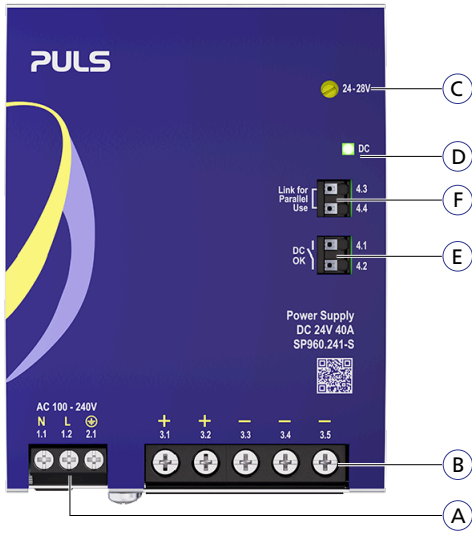

Fig. 15-1: Front side

- A Input terminals**
- | | | |
|-----|---|-----------------------------|
| 1.1 | N | Line input |
| 1.2 | L | Line input |
| 2.1 | ⊕ | PE (Protective Earth) input |
- B Output terminals**
Identical poles are internally connected.
- | | | |
|-----|-----|--------------------------|
| 3.1 | (+) | Positive output |
| 3.2 | (+) | Positive output |
| 3.3 | (-) | Negative output (return) |
| 3.4 | (-) | Negative output (return) |
| 3.5 | (-) | Negative output (return) |
- C Output voltage potentiometer**
Factory setting: 24.1 V
- D DC-OK LED**
Green, when the output voltage is > 90 % of the adjusted output voltage.
- E DC-OK relay contact**
- | | | |
|-----|--------|---|
| 4.1 | Open / | The DC-OK relay monitors the output voltage. When the contact is closed, the DC-OK LED is on. |
| 4.2 | close | contact |
- F "Parallel Use" "Single Use" Link**
- | | | |
|-----|---------|--|
| 4.3 | Link | Link the two terminal poles when power supplies are connected in parallel. In order to achieve a sharing of the load current between the individual power supplies, the "parallel use" regulates the output voltage in such a manner that the voltage at no load is approx. 4 % higher than at nominal load. |
| 4.4 | contact | |

16. EMC

The power supply is suitable for applications in industrial environments as well as in residential, commercial and light industry environments without any restrictions. A detailed EMC report is available on request.

EMC Immunity	According to generic standards: EN IEC 61000-6-1 and EN IEC 61000-6-2			
Electrostatic discharge	EN 61000-4-2	contact discharge	8 kV	Criterion A
		air discharge	15 kV	Criterion A
Electromagnetic RF field	EN 61000-4-3	80 MHz - 6 GHz	20 V/m	Criterion A
Fast transients (Burst)	EN 61000-4-4	input lines	4 kV	Criterion A
		output lines	2 kV	Criterion A
		DC-OK signal (coupling clamp)	2 kV	Criterion A
Surge voltage on input	EN 61000-4-5	L → N	2 kV	Criterion A
		L → PE, N → PE	4 kV	Criterion A
Surge voltage on output	EN 61000-4-5	(+) → (-)	500 V	Criterion A
		(+) / (-) → PE	1 kV	Criterion A
Surge voltage on DC-OK	EN 61000-4-5	DC-OK signal → PE	1 kV	Criterion A
Conducted disturbance	EN 61000-4-6	0.15 - 80 MHz	20 V	Criterion A
Mains voltage dips	EN 61000-4-11	0 % of 100 Vac	0 V, 20 ms	Criterion A
		40 % of 100 Vac	40 V, 200 ms	Criterion C
		70 % of 100 Vac	70 V, 500 ms	Criterion A
		0 % of 200 Vac	0 V, 20 ms	Criterion A
		40 % of 200 Vac	80 V, 200 ms	Criterion A
		70 % of 200 Vac	140 V, 500 ms	Criterion A
Voltage interruptions	EN 61000-4-11	0 % of 200 Vac (=0 V)	5000 ms	Criterion C
Voltage sags	SEMI F47 0706	dips on the input voltage according to SEMI F47 standard		
		80 % of 120 Vac	96 V, 1000 ms	Criterion A
		70 % of 120 Vac	84 V, 500 ms	Criterion A
		50 % of 120 Vac	60 V, 200 ms	Criterion A
Powerful transients	VDE 0160	over entire load range	750 V, 0.3 ms	Criterion A

Performance criteria:

- A: Power supply shows normal operation behavior within the defined limits.
- C: Temporary loss of function is possible. Power supply may shut-down and restarts by itself. No damage or hazards for the power supply will occur.

EMC Emission	According to generic standards: EN IEC 61000-6-3, EN IEC 61000-6-8 and EN IEC 61000-6-4	
Conducted emission input lines	EN 55011, EN 55032, FCC Part 15, CISPR 11, CISPR 32	Class B
Conducted emission output lines	IEC/CISPR 16-1-2, IEC/CISPR 16-2-1	Limits for DC power ports according to EN IEC 61000-6-3 are fulfilled for output floating without restrictions. For negative output connected to earth the requirements are fulfilled for a maximum DC output line length of 25 m.
Radiated emission	EN 55011, EN 55032	Class B
Harmonic input current	EN 61000-3-2	Class A fulfilled; Class C fulfilled load range 8-48 A
Voltage fluctuations, flicker ¹⁾	EN 61000-3-3	fulfilled

This device complies with FCC Part 15 rules.

Operation is subjected to following two conditions: (1) this device may not cause harmful interference, and (2) this device must accept any interference received, including interference that may cause undesired operation.

¹⁾ Tested with constant current loads, non pulsing

Switching Frequencies

PFC converter	70 kHz	nearly constant
Main converter	80 to 115 kHz	output voltage dependent
Auxiliary converter	115 kHz	nearly constant
Microcontroller clock	48 and 128 MHz	

17. Environment

Operational temperature ¹⁾	-25 °C to +70 °C	reduce output power according to Fig. 17-1
Storage temperature	-40 °C to +80 °C	for storage and transportation
Output derating	24 W/°C 9.6 W/°C 19.2 W/°C 60 W / 1000 m or 5 °C / 1000 m	AC 120 – 240 V mains, between +60 °C and +70 °C AC 100 V mains, between 55 °C and +60 °C AC 100 V mains, between +60 °C and +70 °C for altitudes > 2000 m, see Fig. 17-2
	The derating is not hardware controlled. The user has to take care by himself to stay below the derated current limits in order not to overload the unit.	
Humidity	5 - 95% r.h.	according to IEC 60068-2-30 Do not energize while condensation is present.
Atmospheric pressure	54 - 110 kPa	for details, see Fig. 17-2
Altitude	0 to 2000 m 2000 to 5000 m	without any restrictions reduce output power or ambient temperature, see Fig. 17-2.
Over-voltage category	III II	IEC/UL 61010-2-201 up to 2000 m IEC/UL 61010-2-201 2000 m to 5000 m
Degree of pollution	2	IEC/UL 61010-2-201, not conductive
Vibration sinusoidal	2 - 17.8 Hz: ±1.6 mm; 17.8 - 500 Hz: 2 g 2 hours / axis	IEC 60068-2-6
Shock	30 g 6 ms, 20 g 11 ms 3 bumps / direction, 18 bumps in total	IEC 60068-2-27
	Shock and vibration is tested in combination with DIN rails EN 60715 with a height of 15 mm and a thickness of 1.3 mm and standard orientation.	
Audible noise	Some audible noise may be emitted from the power supply during no load, overload or short circuit.	

¹⁾ The operational temperature is the same as the ambient or surrounding temperature. It is defined as the air temperature 3 cm below the device.

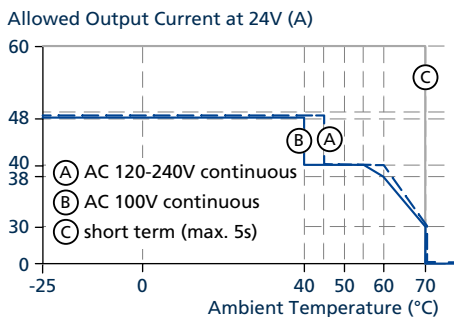

Fig. 17-1: Output current vs. ambient temp.

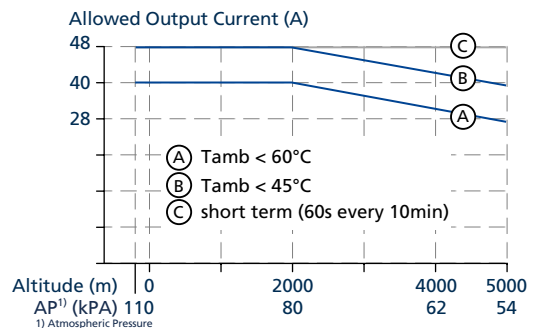

Fig. 17-2: Output current vs. altitude

18. Protection Features

Output overvoltage protection	typ. 31.5 Vdc max. 32 Vdc	In case of an internal power supply defect, a redundant circuit limits the maximum output voltage. The output shuts down and automatically attempts to restart.
Degree of protection	IP20	EN/IEC 60529
Penetration protection	> 5 mm	e.g. screws, small parts
Overtemperature protection	included	output shut-down with automatic restart
Input transient protection	MOV (Metal Oxide Varistor)	for protection values, see chapter 16 (EMC)
Internal input fuse	included	not user replaceable

19. Safety Features

Input / output separation	SELV PELV double or reinforced galvanic insulation	IEC/UL 61010-2-201 IEC/UL 61010-2-201
Class of protection	I	PE (Protective Earth) connection required
Isolation resistance	> 500 MOhm > 500 MOhm > 500 MOhm	at delivered condition between input and output, measured with 500 Vdc at delivered condition between input and PE, measured with 500 Vdc at delivered condition between output and PE, measured with 500 Vdc
PE resistance	< 0.1 Ohm	resistance between PE terminal and the housing in the area of the DIN rail mounting bracket
PE conductor current	typ. 0.2 mA typ. 0.45 mA	at 100 Vac 50 Hz, TN-, TT-mains at 230 Vac 50 Hz, TN-, TT-mains

20. Dielectric Strength

The output voltage is floating and has no ohmic connection to the ground.

Type and factory tests are conducted by the manufacturer. Field tests may be conducted in the field using the appropriate test equipment which applies the voltage with a slow ramp (2 s up and 2 s down). Connect all input-terminals together as well as all output poles before conducting the test. When testing, set the cut-off current settings to the value in the table below.

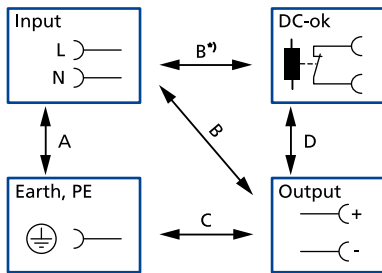

Fig. 20-1: Dielectric strength

	A	B	C	D
Type test (60 s)	2500 Vac	3000 Vac	500 Vac	500 Vac
Factory test (5 s)	2500 Vac	2500 Vac	500 Vac	500 Vac
Field test (5 s)	2000 Vac	2000 Vac	500 Vac	500 Vac
Cut-off current setting for field test	> 20 mA	> 20 mA	> 40 mA	> 1 mA



To fulfil the PELV requirements according to EN 60204-1 § 6.4.1, we recommend that either the (+) pole, the (-) pole or any other part of the output circuit shall be connected to the protective earth system. This helps to avoid situations in which a load starts unexpectedly or can not be switched off when unnoticed earth faults occur.

B⁾ When testing input to DC-OK ensure that the max. voltage between DC-OK and the output is not exceeded (column D). We recommend connecting DC-OK pins and the output pins together when performing the test.

21. Approved, Fulfilled or Tested Standards

IEC 61010	Safety ✓	Manufacturer's Declaration IEC 61010-2-201 - Electrical Equipment for Measurement, Control and Laboratory Use - Particular requirements for control equipment
Semi F47	SEMI F47	Test Report Voltage Sag Immunity for Semiconductor Processing Equipment

22. Regulatory Product Compliance

EU Declaration of Conformity	CE	The CE mark indicates conformance with the European <ul style="list-style-type: none"> - EMC directive - Low-voltage directive (LVD) - RoHS directive
REACH Regulation	REACH ✓	Manufacturer's Declaration EU Regulation regarding the Registration, Evaluation, Authorisation and Restriction of Chemicals EU Regulation 1907 / 2006
WEEE Regulation		Manufacturer's Declaration EU Directive on Waste Electrical and Electronic Equipment Registered in Germany as business to business (B2B) products. EU Directive 2012/19/EU WEEE-Reg.-Nr. DE 55837529
RoHS (China RoHS 2)		Manufacturer's Statement Administrative Measures for the Restriction of the Use of Hazardous Substances in Electrical and Electronic Products 25 years
IEC 61558-2-16 (Annex BB) (planned)	Safety Isolating Transformer	Test Certificate IEC 61558-2-16 - Safety of transformers, reactors, power supply units and similar products for supply voltages up to 1100 V. Particular requirements and tests for switch mode power supply units and transformers for switch mode power supply units.

23. Physical Dimensions and Weight

Width	96 mm
Height	124 mm
Depth	132 mm
	The DIN rail depth must be added to the unit depth to calculate the total required installation depth.
Weight	1700 g
DIN rail	Use 35 mm DIN rails according to EN 60715 or EN 50022 with a height of 7.5 or 15 mm.
Housing material	Body: Aluminium alloy Cover: Zinc-plated steel
Installation clearances (top / bottom / left / right)	40 / 40 / 5 / 5 mm

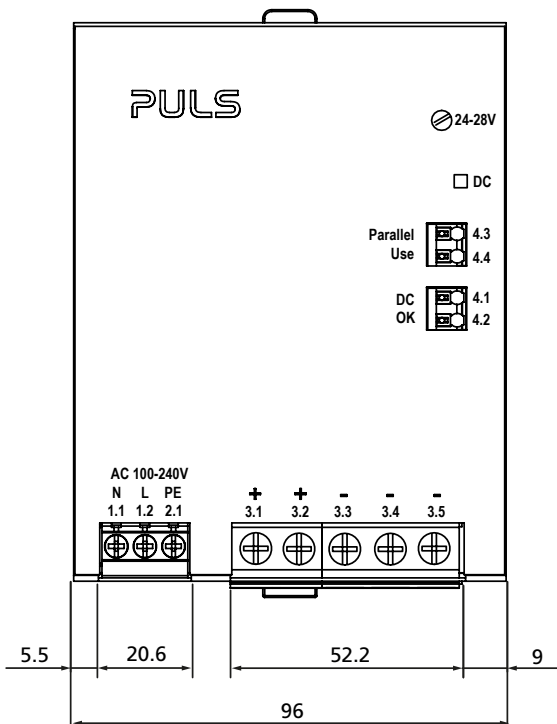

Fig. 23-1: Front view

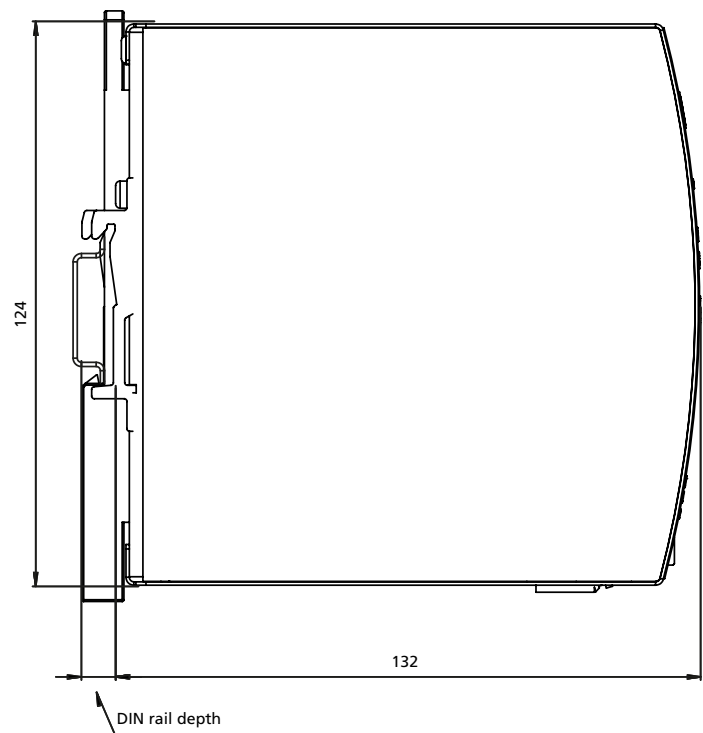

Fig. 23-2: Side view

All dimensions in mm unless otherwise noted.