

POWER SUPPLY 380-480 Vac 24 V 500 W

- IP65 and IP67 degree of protection
- 3AC 380-480 V wide-range input
- Output connected to PE (PELV/ES1)
- 95.6 % full load and excellent partial load efficiencies
- Negligibly low input inrush current surge
- High immunity to transients and power surges
- Low electromagnetic emissions
- Large output capacitors
- DC-OK relay contact
- 3 year warranty

PRODUCT DESCRIPTION

The FPT500 is an industrial grade power supply for a 3-phase mains system that is incorporated into a rugged wall-mount housing with an IP65 and IP67 degree of protection.

It provides 1 stabilised output that is galvanically insulated from the input. The negative terminal of the output is permanently connected to PE within the unit.

The most outstanding features of the FPT series are compact size, wide operating temperature range, extremely low input inrush current and very high efficiencies, which are achieved through various design topologies. The large output capacitors can absorb and store regenerative energy from braking motors.

High immunity to transients and power surges as well as low electromagnetic emissions and an international approval package make the use in nearly every application possible.

SHORT-FORM DATA

Output voltage	DC 24 V	nominal
Adjustment range	24-28 V	factory setting 24.5 V
Output power	500 W	up to +55 °C ambient
	350 W	up to +70 °C ambient
BonusPower	600 W	up to +45 °C ambient
Short term, up to	1000 W / 5 s	up to +55 °C ambient
	700 W / 5 s	up to +70 °C ambient
	Derate linearly between +55 °C to +70 °C	
Number of outputs	1	
Input voltage AC	3AC 380-480 V	±15 %
Power factor	0.94 / 0.95	at 3x 400 / 480 Vac
AC Inrush current	1.9 / 1.8 A _{peak}	at 3x 400 / 480 Vac
Efficiency	95.8 / 95.6 %	at 3x 400 / 480 Vac
Power Losses	22 / 23 W	at 3x 400 / 480 Vac
Hold-up time	24 / 24 ms	at 3x 400 / 480 Vac
Temperature range	-25 °C to +70 °C	
Size (wxhxd)	181x183x59 mm	without connectors
Weight	1200 g	

MAIN APPROVALS

For details and a complete approval list, see chapter 19.



IEC 62368-1
IEC 61010-2-201

UL 61010

Index

1	Intended Use.....	4	18	Dielectric Strength.....	19
2	Installation Instructions.....	4	19	Approved, Fulfilled or Tested Standards.....	20
3	AC Input.....	5	20	Regulatory Product Compliance.....	20
4	DC Input.....	6	21	Accessories.....	21
5	Input Inrush Current.....	6	21.1	DIN Rail Mounting Kit: ZM.FPDRA-11.....	21
6	Output.....	7	21.2	Mounting Bracket: ZM.FPMBA-11.....	21
7	Hold-up Time.....	8	22	Application Notes.....	22
8	DC-OK Relay Contact.....	9	22.1	Repetitive Pulse Loading.....	22
9	Efficiency and Power Losses.....	10	22.2	External Input Protection.....	22
10	Lifetime Expectancy.....	11	22.3	Inductive and Capacitive Loads.....	22
11	MTBF.....	11	22.4	Two Phases Operation.....	22
12	Functional Diagram.....	12	22.5	Back-Feeding Loads.....	22
13	Dimensions and Connectors.....	13	22.6	Parallel Use to Increase Output Power.....	23
14	User Interface.....	14	22.7	Series Operation.....	23
15	EMC.....	16	22.8	Mounting Orientations.....	23
16	Environment.....	17			
17	Safety and Protection Features.....	18			

The information given in this document is correct to the best of our knowledge and experience at the time of publication. If not expressly agreed otherwise, this information does not represent a warranty in the legal sense of the word. As the state of our knowledge and experience is constantly changing, the information in this data sheet is subject to revision. We therefore kindly ask you to always use the latest issue of this document (available under www.pulspower.com).

No part of this document may be reproduced or utilised in any form without our prior permission in writing.

Packaging and packaging aids can and should always be recycled. The product itself may not be disposed of as domestic refuse.

Terminology and Abbreviation

PE and \oplus Symbol	PE is the abbreviation for Protective Earth and has the same meaning as the symbol \oplus .
Earth, Ground (GND)	This document uses the term "earth" which is the same as the U.S. term "ground".
t.b.d.	To be defined, value or description will follow later.
3AC 400 V	A figure displayed with the AC or DC before the value represents a nominal voltage with standard tolerances (usually $\pm 15\%$) included. E.g.: DC 12 V describes a 12 V battery disregarding whether it is full (13.7 V) or flat (10 V)
3x 400 Vac	A figure with the unit (Vac) at the end is a momentary figure without any additional tolerances included.
50 Hz vs. 60 Hz	As long as not otherwise stated, 3AC 400 V parameters are valid at 50 Hz mains frequency.
may	A key word indicating flexibility of choice with no implied preference.
shall	A key word indicating a mandatory requirement.
should	A key word indicating flexibility of choice with a strongly preferred implementation.

Nomenclature

Detail	Description
FPT	380-480 V 3-phase power supply
FPS	100-240 V 1-phase power supply
FPH	200-240 V 1-phase power supply
300	300 W power class
500	500 W power class
241 / 481	Standard power supply with output voltage 24-28 V / 48-52 V setting and LED bar
242 / 482	Basic power supply without voltage setting and LED bar.
245 / 485	Power supply with up to 4 eFuse channels
246 / 486	Power supply with up to 4 NEC Class 2 channels
247 / 487	Power supply with NEC Class 2 and eFuse channel
0xx	Terminal configuration e.g. .002. Input: Han Q 4/2 Com: M12-A Output: Han Q 4/0
1xx	Consecutively numbered

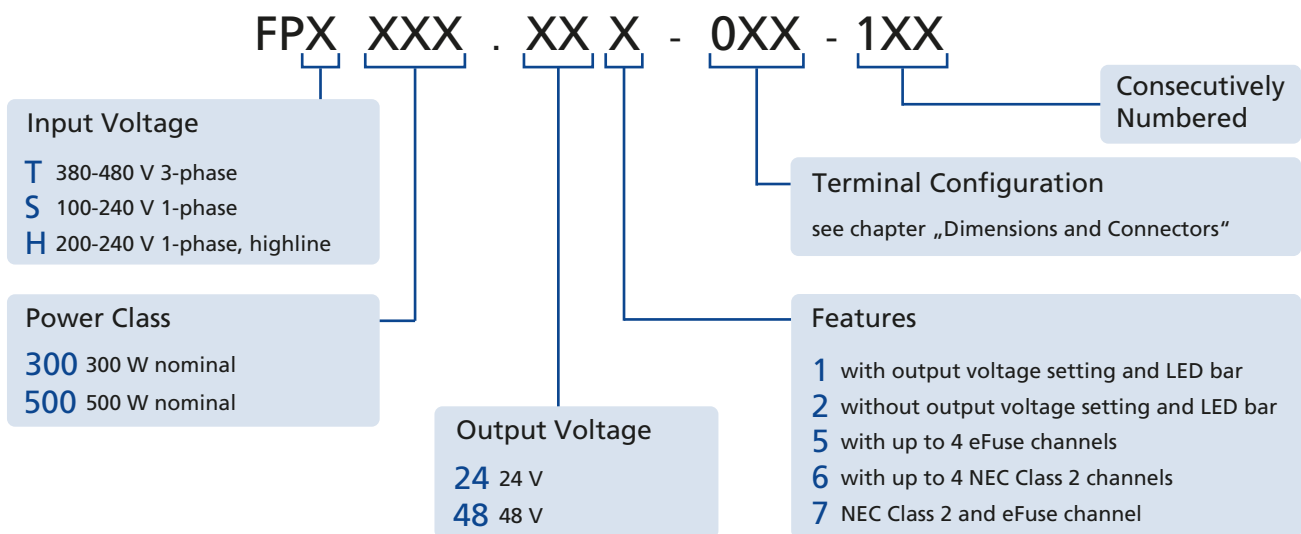

1. Intended Use

This device is designed for indoor use and is intended for commercial use, such as in industrial control, process control, monitoring and measurement equipment.

Do not use this device in equipment where malfunction may cause severe personal injury or threaten human life. If this device is used in a manner outside of its specification, the protection provided by the device may be impaired.

2. Installation Instructions

⚠ DANGER Risk of electrical shock, fire, personal injury or death

- Turn power off before working on the device. Protect against inadvertent re-powering.
- Do not open, modify or repair the device.
- Do not open the unit as high voltages are present inside.
- Do not touch during power-on and immediately after power-off. Hot surfaces may cause burns.
- Install the device on a large enough flat surface. Sharp edges on the back may cause injury.
- If damage or malfunction occur during installation or operation, immediately turn power off and send unit to the factory for inspection.
- The device is designed as “Class of Protection I” equipment according to IEC 61140. Do not use without a proper PE (Protective Earth) connection.

⚠ WARNING Risk of damages to the device

- Keep the following minimum installation clearances: 30 mm on top and bottom, 10 mm on the front, left and right side.
- The maximum surrounding air temperature is +70 °C. The operational temperature is the same as the ambient or surrounding air temperature and is defined 3 cm below the device.
- The device is designed to operate in areas between 5 % and 95 % relative humidity.
- Clean only with a damp cloth.

Obey the following installation instructions:

This device may only be installed and put into operation by qualified personnel. This device does not contain serviceable parts. The tripping of an internal fuse is caused by an internal defect. Install the device onto a flat surface with the terminals on the bottom of the device. Other mounting orientations require a reduction in output power, see chapter 22.8.

For wall mounting use 4 screws. Two on top and 2 on bottom mounting holes. Recommended screw size is M4 (UNC 8-32). The enclosure of the device provides a degree of protection of IP65 and IP67 when installed with all mating connectors firmly connected. The device is designed for pollution degree 3 areas in controlled environments.

Assure that during installation no moisture or dirt gets into the connections. Operation in areas where moisture or condensation can be expected is possible.

The negative potential of the outputs is permanently connected to PE within the unit. Do not connect the negative potential of any output to PE outside the unit.

For TN-, TT-mains systems with earthed neutral and IT star mains systems with insulation monitoring the device is designed for overvoltage category III zones up to 2000 m and for overvoltage category II zones up to 5000 m.

For TN-, TT-, IT-delta mains systems or IT star mains systems without insulation monitoring the device is intended for overvoltage category II zones up to 2000 m.

Functionality is limited.

The device is designed for altitudes up to 5000 m. Above 2000 m a reduction in output current is required and the operation is limited according mains systems described above. The device is designed, tested and approved for branch circuits up to 30 A (UL) and 32 A (IEC) without additional protection device. If an external fuse is utilized, do not use circuit breakers smaller than 6 A B- or C-characteristic to avoid an unintentional tripping. A disconnecting means shall be provided for the input of the device. This must be suitably located and easily accessible. The disconnecting means must be marked as the such for the device.

3. AC Input

The device is suitable to be supplied from TN-, TT- or IT-mains networks. For more details, see chapter 2.
An operation on only two legs of a three-phase system is possible with slightly different parameters, see chapter 22.4.

AC input voltage rated range nom. 3AC 380-480 V
AC input operating range 3x 323-552 Vac

Input frequency	nom. 50-60 Hz	±6 %
Turn-on voltage	typ. 3x 320 Vac	steady-state value, see Fig. 3-1
Shut-down voltage	typ. 3x 300 Vac	steady-state value, see Fig. 3-1
External input protection	see recommendations in chapter 2	

	3AC 400 V	3AC 480 V	
Input current	typ. 0.8 A	0.66 A	at 500 W, symmetrical phase voltages, see Fig. 3-3
Power factor	typ. 0.94	0.95	at 500 W, see Fig. 3-4
Start-up delay	typ. 1000 ms	1000 ms	at 500 W, symmetrical phase voltages, see Fig. 3-2
Rise time	typ. 10 ms	10 ms	at 500 W, constant current load, 0 mF, see Fig. 3-2
	typ. 12 ms	12 ms	at 500 W, constant current load, 12.5 mF, see Fig. 3-2
Turn-on overshoot	max. 500 mV	500 mV	see Fig. 3-2

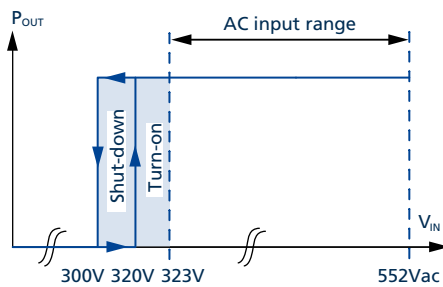

Fig. 3-1: Input voltage range

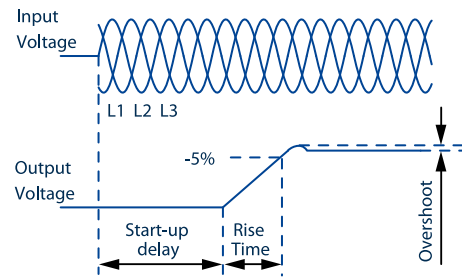

Fig. 3-2: Turn-on behaviour, definitions

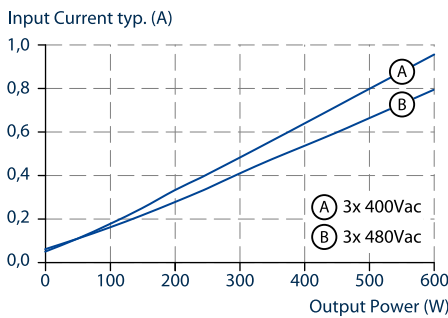

Fig. 3-3: Input current vs. output power at 24 V output voltage

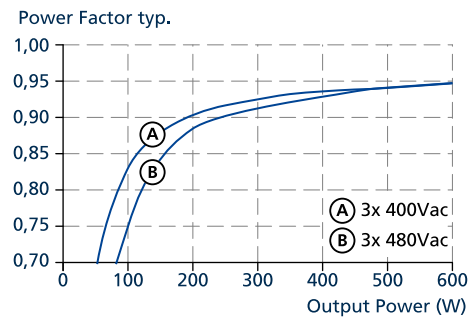

Fig. 3-4: Power factor vs. output power at 24 V output voltage

4. DC Input

Do not operate this power supply with DC input voltage.

5. Input Inrush Current

The power supply is equipped with an active inrush current limitation circuit, which limits the input inrush current after turn-on to an extremely low value. The inrush current is usually smaller than the steady-state input current.

		3AC 400 V	3AC 480 V	
Inrush current ¹⁾	max.	2.1 A _{peak}	2 A _{peak}	temperature independent
	typ.	1.9 A _{peak}	1.8 A _{peak}	temperature independent

¹⁾ The charging current into EMI suppression capacitors is disregarded in the first microseconds after switch-on.

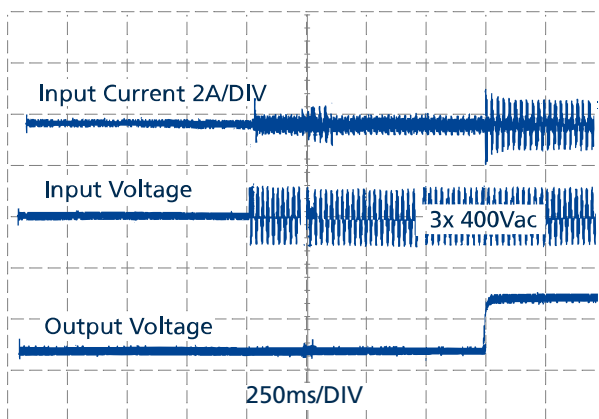

Fig. 5-1: Typical turn-on behavior at nominal load and +25 °C ambient temperature

6. Output

The output provides a (PELV/ES1) rated voltage, which is galvanically isolated from the input voltage. The negative potential of the outputs is permanently connected to PE within the unit. Do not connect any output to PE (Ground).

The device is designed to supply any kind of loads, including capacitive and inductive loads. If capacitors with a capacitance > 100 mF are connected to the output, the unit might charge the capacitor in overcurrent mode.

Number of outputs		1	
Output voltage	nom.	24 V	
Adjustment range		24-28 V	adjustable in steps: 24 V, 24.5 V, 25 V, 25.5 V, 26 V, 26.5 V, 27 V and 28 V
Factory settings	typ.	24.5 V	±0.2 %, at nominal load
Line regulation	max.	10 mV	between 323 and 552 Vac input voltage change
Load regulation	typ.	100 mV	between 0 and 600 W output load, static value
Ripple and noise voltage	max.	100 mVpp	bandwidth 20 Hz to 20 MHz, 50 Ohm
Total output power	nom.	600 W	up to +45 °C ambient temperature, for all outputs in total
	nom.	500 W	up to +55 °C ambient temperature, for all outputs in total
	nom.	350 W	up to +70 °C ambient temperature, for all outputs in total
Short term up to 5 s	nom.	1000 W	up to +55 °C ambient temperature, for all outputs in total
	nom.	700 W	up to +70 °C at ambient temperature, for all outputs in total
			Derate linearly between +45 °C and +70 °C, see Fig. 16-1.
Overload / short-circuit current	typ.	42 A / 0 A	continuous current, see Fig. 6-1 At heavy overloads (when output voltage falls below 13 V), the power supply delivers continuous output current for 2 s. After this, the output is switched off for approx. 18 s before a new start attempt is automatically performed. This cycle is repeated as long as the overload exists. If the overload has been cleared, the device will operate normally, see Fig. 6-2. Load impedance 10 mOhm. Discharge current of output capacitors is not included.
Output capacitance	typ.	12 500 µF	included inside the power supply, for all outputs in total
Back-feeding loads	max.	35 V / 4 J	The unit is resistant and does not show a malfunction when a load feeds back voltage to the power supply. It does not matter whether the power supply is on or off, for all outputs in total.

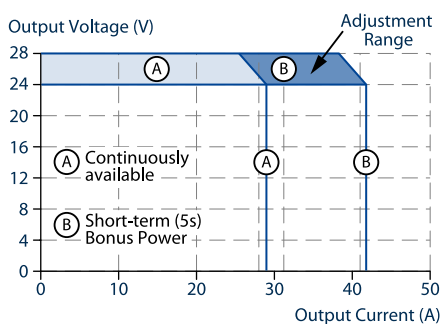

Fig. 6-1: Output voltage vs. output current

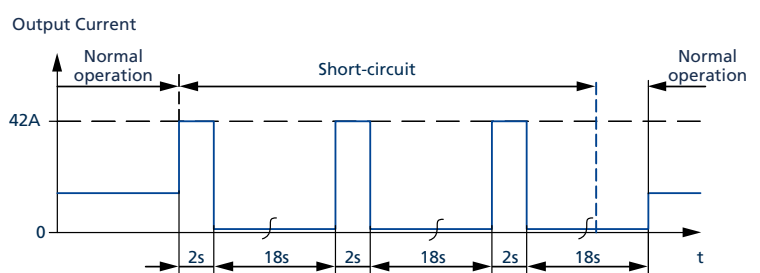

Fig. 6-2: Short-circuit on output, overcurrent mode, typ.

7. Hold-up Time

The hold-up time is the time during which a power supply's output voltage remains within specification following the loss of input power. The hold-up time is output load dependent. At no load, the hold-up time can be up to several seconds. The status LED is also on during this time.

		3AC 400 V	3AC 480 V	
Hold-up time	typ.	56 ms	56 ms	at 250 W output load, see Fig. 7-1
	min.	47 ms	47 ms	at 250 W output load, see Fig. 7-1
	typ.	24 ms	24 ms	at 500 W output load, see Fig. 7-1
	min.	20 ms	20 ms	at 500 W output load, see Fig. 7-1

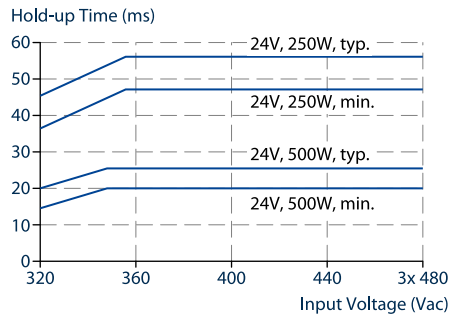

Fig. 7-1: Hold-up time vs. input voltage

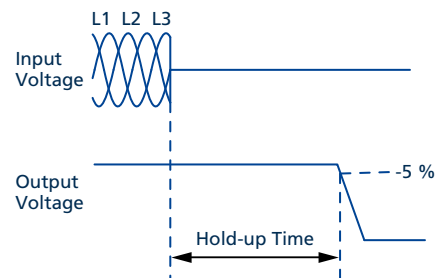

Fig. 7-2: Shut-down behavior, definitions

8. DC-OK Relay Contact

This feature monitors the output voltage, which is produced by the power supply itself. It is independent of an eventually present external voltage on the output of the power supply.

Contact closes	As soon as the output voltage reaches typ. 90 % of the adjusted output voltage. The DC-OK relay contact is synchronized with the status LED.
Contact opens	As soon as the output voltage dips below 90 % of the adjusted output voltage. Short dips will be extended to a signal length of 100 ms. Dips shorter than 1 ms will be ignored.
Switching hysteresis	1 V
Contact ratings	maximal 60 Vdc 0.3 A, 30 Vdc 1 A, 30 Vac 0.5 A, resistive load minimal permissible load: 1 mA at 5 Vdc
Isolation voltage	see chapter 18, dielectric strength table

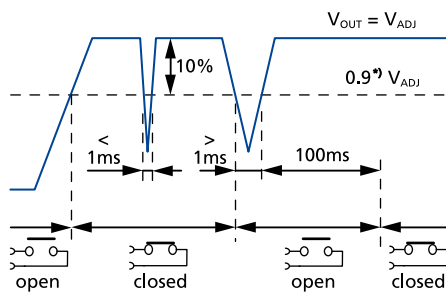

Fig. 8-1: DC-OK relay contact behavior

9. Efficiency and Power Losses

		3AC 400 V	3AC 480 V	
Efficiency	typ.	95.8 %	95.6 %	at 24 V, 500 W
Average efficiency ¹⁾	typ.	94.2 %	94 %	25 % at 120 W, 25 % at 250 W, 25 % at 370 W, 25 % at 500 W
Power losses	typ.	2.5 W	2.5 W	at 24 V, 0 W
	typ.	12 W	13 W	at 24 V, 250 W
	typ.	22 W	23 W	at 24 V, 500 W
	typ.	t.b.d. W	t.b.d. W	at 24 V, 600 W

1) The average efficiency is an assumption for a typical application where the power supply is loaded with 25 % of the nominal load for 25 % of the time, 50 % of the nominal load for another 25 % of the time, 75 % of the nominal load for another 25 % of the time and with 100 % of the nominal load for the rest of the time.

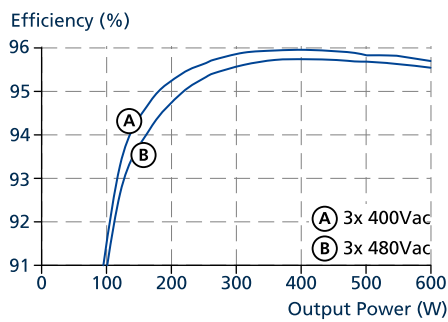

Fig. 9-1: Efficiency vs. output power at 24 V, typ.

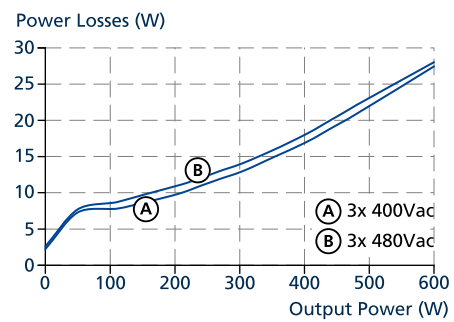

Fig. 9-2: Losses vs. output power at 24 V, typ.

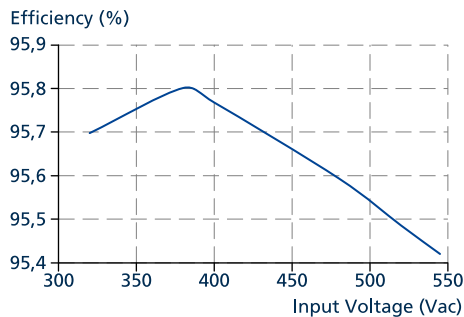

Fig. 9-3: Efficiency vs. input voltage at 24 V, 500 W, typ.

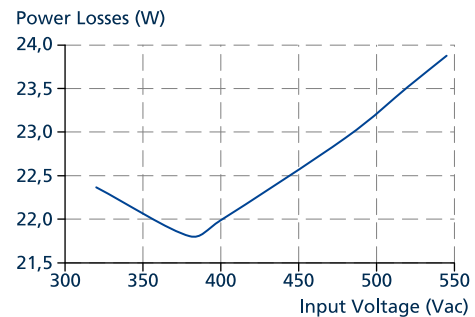

Fig. 9-4: Losses vs. input voltage at 24 V, 500 W, typ.

10. Lifetime Expectancy

The lifetime expectancy shown in the table indicates the minimum operating hours (service lifetime) and is determined by the lifetime expectancy of the built-in electrolytic capacitors. Lifetime expectancy is specified in operational hours and is calculated according to the capacitor’s manufacturer specification. The manufacturer of the electrolytic capacitors only guarantees a maximum lifetime of up to 15 years (131 400 h). Any number exceeding this value is a calculated theoretical lifetime, which can be used to compare devices.

	3AC 400 V	3AC 480 V	
Calculated lifetime expectancy	78 000 h	74 000 h	at 24 V, 500 W and +40 °C
	218 000 h	185 000 h	at 24 V, 250 W and +40 °C
	139 000 h	133 000 h	at 24 V, 500 W and +25 °C
	615 000 h	525 000 h	at 24 V, 250 W and +25 °C

11. MTBF

MTBF stands for **Mean Time Between Failures**, which is calculated according to statistical device failures, and indicates reliability of a device. It is the statistical representation of the likelihood of a unit to fail and does not necessarily represent the lifetime of a product.

The MTBF figure is a statistical representation of the likelihood of a device to fail. An MTBF figure of e.g. 1 000 000 h means that statistically one unit out of 10 000 installed units will fail every 100 h. However, it can not be determined if the failed unit has been running for 50 000 h or only for 100 h.

For these types of units the MTTF (**Mean Time To Failures**) value is the same value as the MTBF value.

	3AC 400 V	3AC 480 V	
MTBF SN 29500, IEC 61709	315 000 h	290 000 h	at 24 V, 500 W and +40 °C
	580 000 h	537 000 h	at 24 V, 500 W and +25 °C
MTBF MIL HDBK 217F	127 000 h	120 000 h	at 24 V, 500 W and +40 °C; Ground Benign GB40
	193 000 h	184 000 h	at 24 V, 500 W and +25 °C; Ground Benign GB25
	35 000 h	35 000 h	at 24 V, 500 W and +40 °C; Ground Fixed GF40
	47 000 h	45 000h h	at 24 V, 500 W and +25 °C; Ground Fixed GF25

12. Functional Diagram

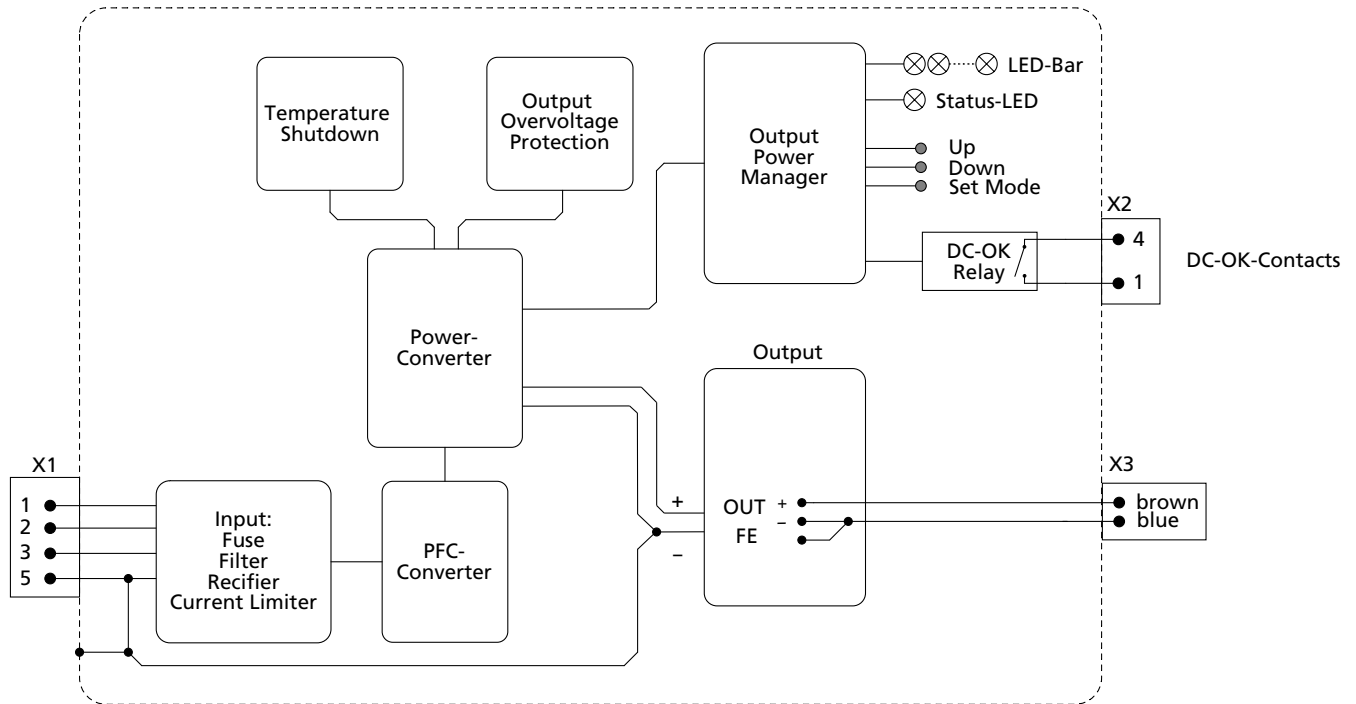
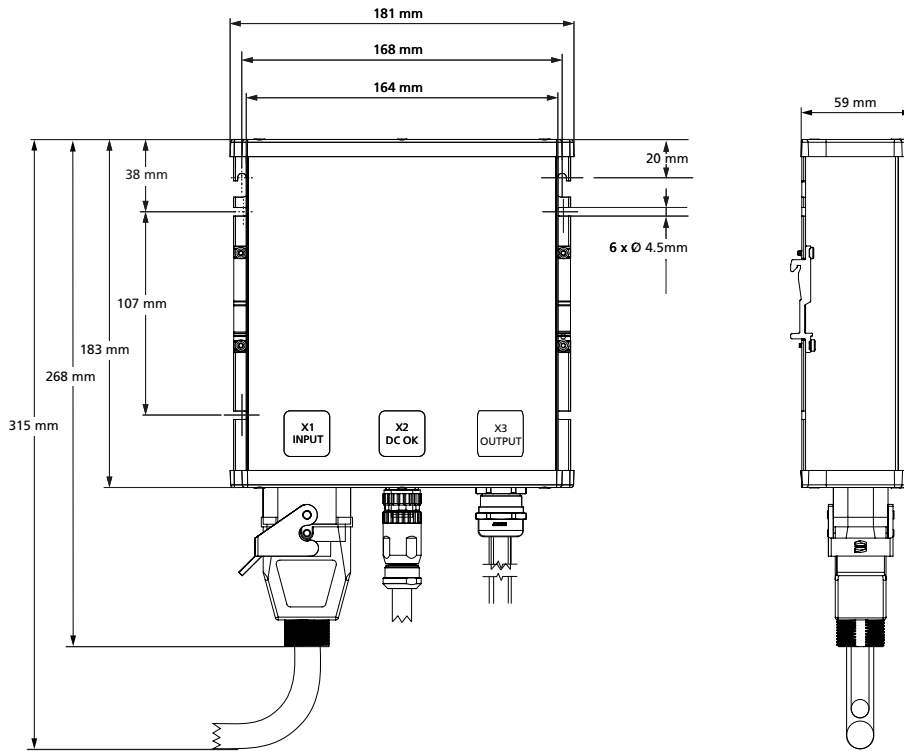

Fig. 12-1: Functional Diagram FPT500.241-006-104

13. Dimensions and Connectors



Width: 181 mm
 Height: 183 mm
 Depth: 59 mm
 Weight: 1200 g

Housing body material: Aluminium alloy
 Housing cover material: Hi-grade polycarbonate
 Installation clearances: See chapter 2

Input connector on power supply (X1):

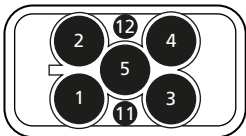

Han Q 4/2 male

- Pin 1: L1
- Pin 2: L2
- Pin 3: L3
- Pin 4: Not connected
- Pin 5: PE connection ⚡

DC-OK connector on power supply (X2):

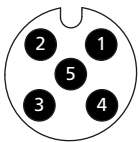

M12-A 5pin male

- Pin 1: Relay connection
- Pin 2: Not connected
- Pin 3: Not connected
- Pin 4: Relay connection
- Pin 5: Not connected

Output connector on power supply (X3):

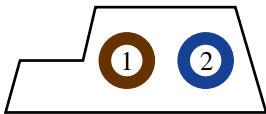

ASI cable 2.5mm²

- Brown cable (1): 24 Vdc
- Blue cable (2): GND

All parameters are specified at 24 V, 500 W, 3x 400 Vac, 25 °C ambient and after a 5 minutes run-in time unless otherwise noted.

14. User Interface

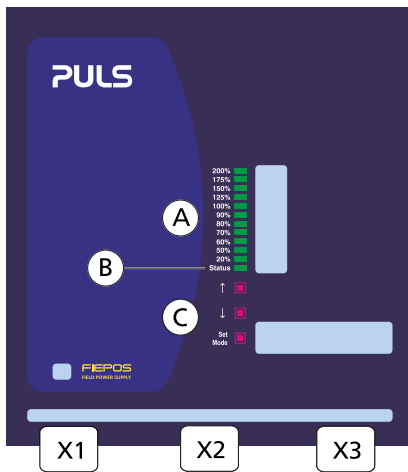

X1	Input connector
X2	DC-OK connector
X3	Output connector
A	LED bar
B	Status LED
C	Set Mode and UP / DOWN buttons

Overview

LED bar (A)

The LED bar is a multifunctional display. The main function is to monitor the sum of all outputs (percentages scale). It also can display the output voltage (voltage scale) and output power (percentage scale) for the individual outputs. The integrated status LED displays different running conditions of the device in real-time.

Status LED (B)

The Status LED displays different running conditions of the device in real-time.

Output level controls (C)

The output level controls consist of the Set Mode button and the UP / DOWN buttons. The Set Mode button is used to change into tripping current settings. The UP / DOWN buttons are used to adjust different output levels or change into the output current mode.

Operation settings

Monitor output power mode

The output power mode displays the actual total output power after startup. It is the default mode of the LED bar. The output power is displayed in percentages of 500 W. If the LED bar is powered up till e.g. 50 %, 250 W is expended. If the LED bar rises above 100 % and therefore exceeds 500 W the 125 %-LED flashes orange. Refer to the percentage scale on the left sidebar.

Set output voltage

To set a new output voltage:

- Press Set Mode button for 3 s. The LED bar lights up once and the set voltage is displayed.
- Push UP / DOWN button to increase or decrease the set point, see voltage scale on the right sidebar.
- New point is set.
- After 15 s of non-action, the device will automatically switch to output power mode.

Set button lock





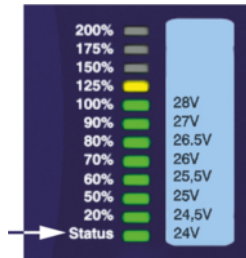

To activate / deactivate the button lock:

- Press the UP / DOWN buttons simultaneously for 3 s. The LED bar will flash for 5 s to indicate the changed button lock status.

LED signaling

The Status LED (B) displays different running conditions of the device in real-time.



- 
Green: On
 DC voltage is above 90 % of output voltage and all outputs are operating according to their settings.
- 
Off
 DC voltage is below 90 % of output voltage or power supply is not powered.
- 
Orange: Two face operation
 See chapter 22.4.
- 
Flashes orange: Overcurrent
 Output is off during these 18 s.
- 
Red: AC input failure
 AC input drops below the specified levels.
- 
Flashes red: Overtemperature
 The unit has turned off due to overtemperature. As soon as the temperature reaches normal operating range the output turns on again and the status LED changes to solid green.

15. EMC

The EMC behavior of the device is designed for applications in industrial environment as well as in residential, commercial and light industry environments.

The device is investigated according to EN 61000-6-1, EN 61000-6-2, EN 61000-6-3, EN 61000-6-4, EN 61000-3-2 and EN 61000-3-3.

EMC immunity

Electrostatic discharge	EN 61000-4-2	contact discharge	8 kV	Criterion A
Air discharge		air discharge	15 kV	Criterion A
Electromagnetic RF field	EN 61000-4-3	80 MHz - 2.7 GHz	15 V/m	Criterion A
		2.7 GHz - 6 GHz	10 V/m	Criterion A
Magnetic field	EN 61000-4-8	50 Hz / 60 Hz	30 A/m	Criterion A
Fast transients (Burst)	EN 61000-4-4	AC input lines	4 kV	Criterion A
		DC output lines	4 kV	Criterion A
		DC-OK	2 kV	Criterion A
Surge voltage on AC input	EN 61000-4-5	Lx to Ly	2 kV	Criterion A
		L to -PE	4 kV	Criterion A
Surge voltage on DC output	EN 61000-4-5	+ to -	1 kV	Criterion A
		+/- to PE	1 kV	Criterion A
Surge voltage on DC-OK	EN 61000-4-5	DC-OK to PE	1 kV	Criterion A
Conducted immunity	EN 61000-4-6	0.15-80 MHz	20 V	Criterion A
Voltage dips	EN 61000-4-11	0 V	1 cycle	Criterion A
		40 % of V_{nom}	200 ms	Criterion A
		70 % of V_{nom}	500 ms	Criterion A
Voltage interruptions	EN 61000-4-11	0 V	5000 ms	Criterion C
Powerful transients	VDE 0160	over entire load range	1550 V, 1.3 ms	Criterion A

Performance criterions:

A: The device shows normal operation behavior within the defined limits.

C: Temporary loss of function is possible. The device may shut-down and restarts by itself. No damage or hazards for the device will occur.

EMC Emission

Conducted emission AC input lines	EN IEC 61000-6-3, EN 55032, EN 55011	Class B
Conducted emission DC output lines	EN IEC 61000-6-3	
Radiated emission	EN IEC 61000-6-3, EN 55032, EN 55011	Class B
Harmonics	EN 61000-3-2	Class A fulfilled between 0 A and 12 A load
Voltage fluctuations, flicker	EN 61000-3-3	pass tested with constant current loads, non pulsing

This device complies with FCC Part 15 rules.

Operation is subjected to following two conditions: (1) this device may not cause harmful interference, and (2) this device must accept any interference received, including interference that may cause undesired operation.

Switching Frequencies

PFC converter	20 kHz to 135 kHz	input voltage and output load dependent
Main converter	60 kHz to 140 kHz	output load dependent
Auxiliary converter	54 kHz to 66 kHz	output load dependent
Microcontroller clocks	48 MHz and 32 MHz	fixed frequency

16. Environment

Operational temperature	-25 °C to +70 °C	Operational temperature is the same as the ambient or surrounding temperature and is defined as the air temperature 3 cm below the unit.
Storage temperature	-40 °C to +85 °C	for storage and transportation
Output derating	10 W / °C 20 W / 1000 m or 5 °C / 1000 m for altitudes > 2000 m, see Fig. 16-2 The derating is not hardware controlled. The application has to stay below the derated current limits in order not to overload the unit.	between +55 °C and +70 °C, see Fig. 16-1
Humidity	5-95 % r.h.	according to IEC 60068-2-30
Atmospheric pressure	54-110 kPa	see Fig. 16-2
Altitude	up to 5000 m	see Fig. 16-2
Over-voltage category	III	according to IEC 60664-1 for TN-, TT-mains systems with earthed neutral and IT star mains systems with insulation monitoring for altitudes up to 2000 m
	II	according to IEC 60664-1 for TN-, TT-mains systems with earthed neutral and IT star mains systems with insulation monitoring for altitudes between 2000 m and 5000 m according to IEC 60664-1 for TN-, TT-, IT-delta mains systems or IT star mains systems without insulation monitoring for altitudes up to 2000 m
Degree of pollution	3	according to IEC 62477-1, not conductive
Vibration sinusoidal	2-17.8 Hz: ±1.6 mm; 17.8-500 Hz: 2 g 2 hours / axis	according to IEC 60068-2-6
Shock	30 g 6 ms, 20 g 11 ms 3 bumps / direction, 18 bumps in total	according to IEC 60068-2-27
	Shock and vibration is tested in combination with DIN rails according to EN 60715 with a height of 15 mm and a thickness of 1.3 mm and standard orientation.	
Audible noise	Some audible noise may be emitted from the power supply during no load, overload or short circuit.	

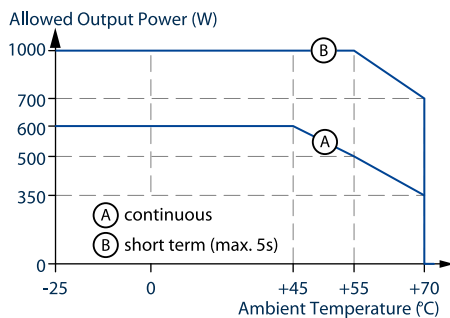

Fig. 16-1: Output power vs. ambient temp.

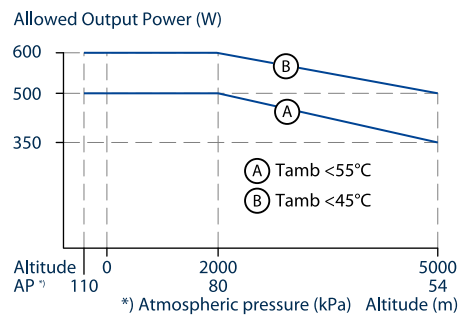

Fig. 16-2: Output power vs. altitude

17. Safety and Protection Features

Isolation resistance	min.	500 MOhm	at delivered condition between input and output, measured with 500 Vdc
	min.	500 MOhm	at delivered condition between input and PE, measured with 500 Vdc
	min.	500 MOhm	at delivered condition between output and Output OK contacts, measured with 500 Vdc
PE resistance	max.	0.1 Ohm	resistance between PE terminal and housing
Input / Output separation		PELV/ES1	IEC/EN/UL 61010-2-201, IEC/EN 62368-1, IEC/EN 60950-1
Output overvoltage protection	typ.	31.8 Vdc	
	max.	32.5 Vdc	In case of an internal defect, a redundant circuit limits the maximum output voltage. The output shuts down and automatically attempts to restart.
Class of protection		I	according to IEC 61140 a PE (Protective Earth) connection is required
Degree of protection		IP65 and IP67	according to EN/IEC 60529
Overtemperature protection		included	Output shut down with automatic restart. Temperature sensors are installed on critical components inside the unit and the unit turns off in safety critical situations, which can happen, e.g. when ambient temperature is too high, ventilation is obstructed or the derating requirements are not followed. There is no correlation between the operating temperature and turn-off temperature since this is dependent on input voltage, load and installation methods.
Input transient protection		MOV (Metal Oxide Varistor)	for protection values, see chapter 15.
Internal input fuse		included	not user replaceable slow-blow high-breaking capacity fuse, 6.3 A (T)
Leakage Current	max.	0.56 mA	at 552 Vac, 60 Hz, TN-,TT-mains / IT-mains

18. Dielectric Strength

The negative terminals of the outputs are permanently connected to PE within the unit. The output is separated from the input by a double or reinforced insulation.

Type and routine tests are conducted by the manufacturer. Field tests may be conducted in the field using the appropriate test equipment which applies the voltage with a slow ramp (2 s up and 2 s down). Connect all input terminals before conducting the test. When testing, set the cut-off current settings to the value in the table below.

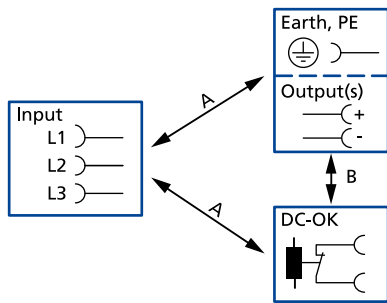





Fig. 18-1: Dielectric strength

		A	D
Type test	60 s	2830 Vac	500 Vac
Routine test	5 s	2550 Vac	500 Vac
Field test	5 s	2000 Vac	500 Vac
Cut-off current setting for field test		> 10 mA	> 10 mA

19. Approved, Fulfilled or Tested Standards

IEC 62368	CB Report	CB Scheme Certificate IEC 62368-1 - Audio / video, information and communication technology equipment - Safety requirements Output safety level: ES1
IEC 61010	CB Report	CB Scheme Certificate IEC 61010-2-201 - Electrical Equipment for Measurement, Control and Laboratory Use - Particular requirements for control equipment
IEC 60950	Safety ✓	Manufacturers Declaration IEC 60950-1 – General safety requirements for Information Technology Equipment (ITE)
UL 61010		UL Certificate Listed equipment for category NMTR - UL 61010-2-201 - Electrical equipment for measurement, control and laboratory use - Particular requirements for control equipment Applicable for US and Canada E-File: E198865
Semi F47	SEMI F47	Test Report Voltage Sag Immunity for Semiconductor Processing Equipment Tested for AC 400 V L-L mains voltages, nominal output voltage and nominal output load
VDMA 24364	LABS VDMA 24364-C1-L/W	Paint Wetting Impairment Substances Test (or LABS-Test) Tested for Zone 2 and Test Class C1 according to VDMA 24364-C1-L/W for solvents and water-based paints

20. Regulatory Product Compliance

EU Declaration of Conformity		The CE mark indicates conformance with the European <ul style="list-style-type: none"> - EMC directive - Low-voltage directive (LVD) - RoHS directive
WEEE Directive		Manufacturer's Declaration EU-Directive on Waste Electrical and Electronic Equipment (WEEE) registered in Germany as business to business (B2B) products. WEEE-Reg.-Nr. DE 55837529
REACH Regulation (EU)	REACH ✓	Manufacturer's Statement EU regulation regarding the Registration, Evaluation, Authorisation and Restriction of Chemicals (REACH) fulfilled.
RoHS-China		Manufacturer's Statement Administrative Measures for the Restriction of the Use of Hazardous Substances in Electrical and Electronic Products 25 years
IEC/EN 61558-2-16 (Annex BB)	Safety Isolating Transformer	Safety Isolating Transformers corresponding to Part 2-6 of the IEC/EN 61558

21. Accessories

21.1. DIN Rail Mounting Kit: ZM.FPDRA-11

In addition to screw mounting FIEPOS can easily be attached to a DIN rail using the ZM.FPDRA-11 DIN rail mounting kit.

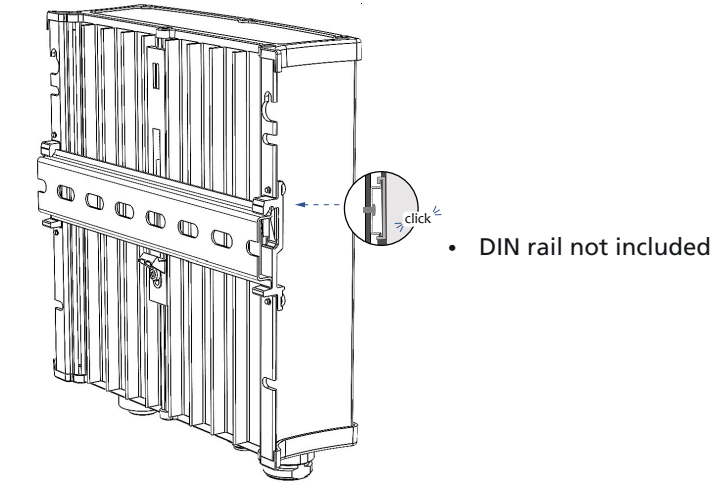

21.2. Mounting Bracket: ZM.FPMBA-11

In addition to screw mounting FIEPOS can easily be attached onto surfaces using the mounting bracket ZM.FPMBA-11.

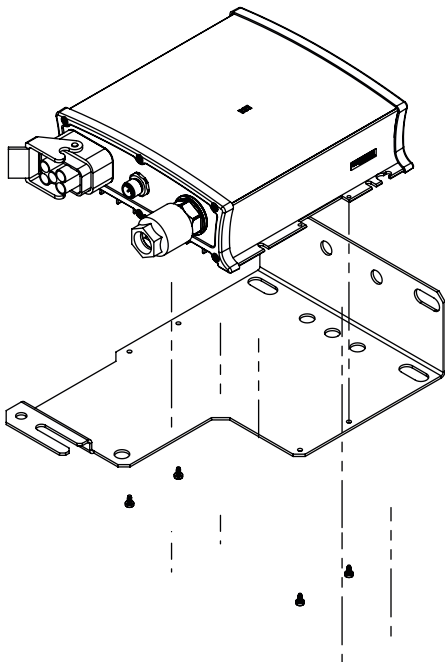

22. Application Notes

22.1. Repetitive Pulse Loading

Typically, a load current is not constant and varies over time. This power supply is designed to support loads with a higher short-term power demand. The short-term duration is hardware controlled by an output power manager and is available on a repeated basis. If the average load is higher than the sum of all output power, the output voltage will dip.

To avoid this, the following rules must be followed:

- a) The power demand of the pulse must be below 200 % of the nominal output power.
- b) The duration of the pulse power must be shorter than the allowed short-term power time, see chapter 6.
- c) The average power should be lower than the nominal output power.

The R.M.S. output current must be below the specified continuous output current. If the R.M.S. current is higher, the unit may respond with a thermal shut-down after a period of time.

22.2. External Input Protection

The device is designed, tested and approved for branch circuits up to 30 A (UL) and 32 A (IEC) without an additional protection device. If an external device (fuse or circuit breaker) is utilized, do not use fuses or circuit breaker smaller than 6 A B- or C-Characteristic to avoid a unintentional tripping.

22.3. Inductive and Capacitive Loads

The power supply is designed to supply any kind of loads, including capacitive and inductive loads. If extreme large capacitors, such as EDLCs (electric double layer capacitors or "UltraCaps") with a capacitance larger than 100 mF are connected to the output, the power supply might charge the capacitor or the output might trip, see chapter 6.

22.4. Two Phases Operation

No external protection devices are required to protect against a phase-loss.

Continuous two phase operation is not recommended for this power class since the supplying 3-phase network could become unbalanced. However, if one phase fails, the unit may continue to operate if the load is below the power limit shown in Fig. 22-1.

Exceeding these limits for an extended period may result in a thermal shut-down of the unit.

During power-on, some start-up attempts can occur until a permanent output power is available. EMC performance, hold-up time, losses, and output ripple differ from a three phase operation. Such use is not included in the approval according to UL 61010 and IEC 62368.

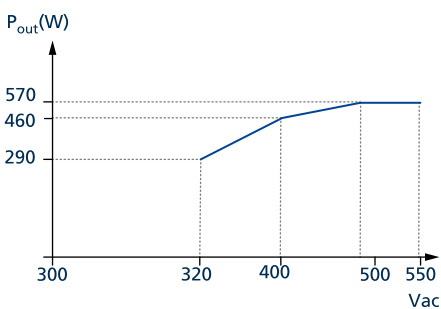
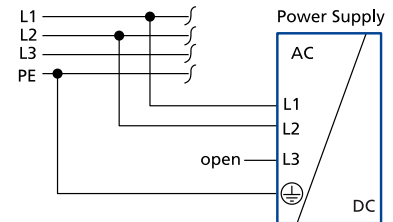

Fig. 22-1: Two phase power capability

22.5. Back-Feeding Loads

Loads such as decelerating motors and inductors can feed voltage back to the power supply. This feature is also called return voltage immunity or resistance against Back-E.M.F. (Electro Magnetic Force).

This power supply is resistant and does not show malfunctioning when a load feeds back voltage to the power supply below 35 V / 4 J. It does not matter whether the power supply is on or off.

22.6. Parallel Use to Increase Output Power

Do not use parallel devices for higher output currents.

22.7. Series Operation

Do not connect power supplies in series.

22.8. Mounting Orientations

The device can be panel mounted in various mounting orientations. The listed lifetime and MTBF values from this datasheet apply only for the standard mounting orientation. The following curves give an indication for allowed output power in different mounting orientations for altitudes up to 2000 m.

A
Standard orientation

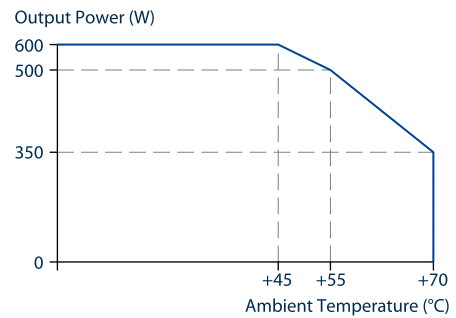
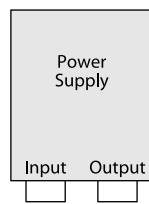

B
Upside down

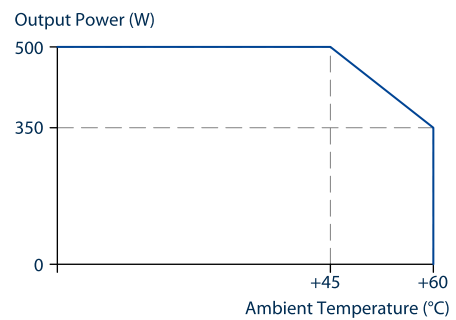
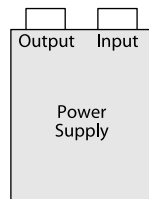

C
Horizontal clockwise
and counter clockwise

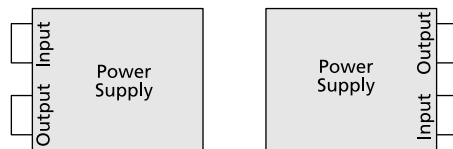

D
Over-head and table-top mounting

